



Deadweight of the cycle rack: 2.8 kg

Assembly instructions First remove the ends caps with a hammer and punch, a U bracket may be used as an alternative if a punch is not available (See Fig 0).

Mount the hand wheel **B** to the tubular bracket using the screw **G** and the spring **D**(Fig 1). The cycle rack should be mounted to the front support bar using the enclosed U-bracket **U** and knurled nuts **M** (Fig 3). Mount the cycle rack to the roof support. Mount the cycle rack to the rear support. Push the T-slide **L** into the bottom of the profile rail. Place the cycle rack onto the roof support and align. Use the assembly plate and the toggle nuts to attach the cycle rack. Place the clamp jaws of the lower plate **J** to the front sloping frame part of the cycle and tighten using the hand wheel **B**. Attach pivot screw using the lockable tog nut **A**. Slide the belt guides **N** into place before installing the end caps **P** and tighten the wheels in the profile rail using the holding straps **H** (Fig 2).

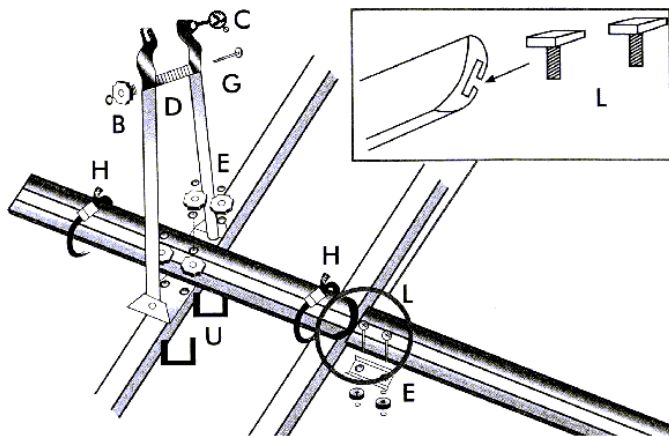

FIG. 0



Safety information:

Check the screws for the first time after driving a short distance and then at regular intervals. Please note that the load on the roof will change the driving properties of your vehicle during braking, in the case of side winds and when driving round bends. Adjust your driving speed accordingly. In particular, observe the information provided by the manufacturer of the vehicle about the permitted roof loads. Parts of the cycles, such as e.g. handlebars or pedals, should not protrude over the edge of the roof. If not needed, the cycle rack should be dismantled for reasons of safety for other road users and economy (petrol consumption). CAUTION: When the cycle is mounted, note the greater height of your vehicle when entering underground car parks, tunnels etc. Before setting off on your journey, always check that the attachments are all correct. IMPORTANT: Always use the supplied holding belt. Deadweight of the cycle rack: 2.8 kg

FIG. 1



FIG. 2

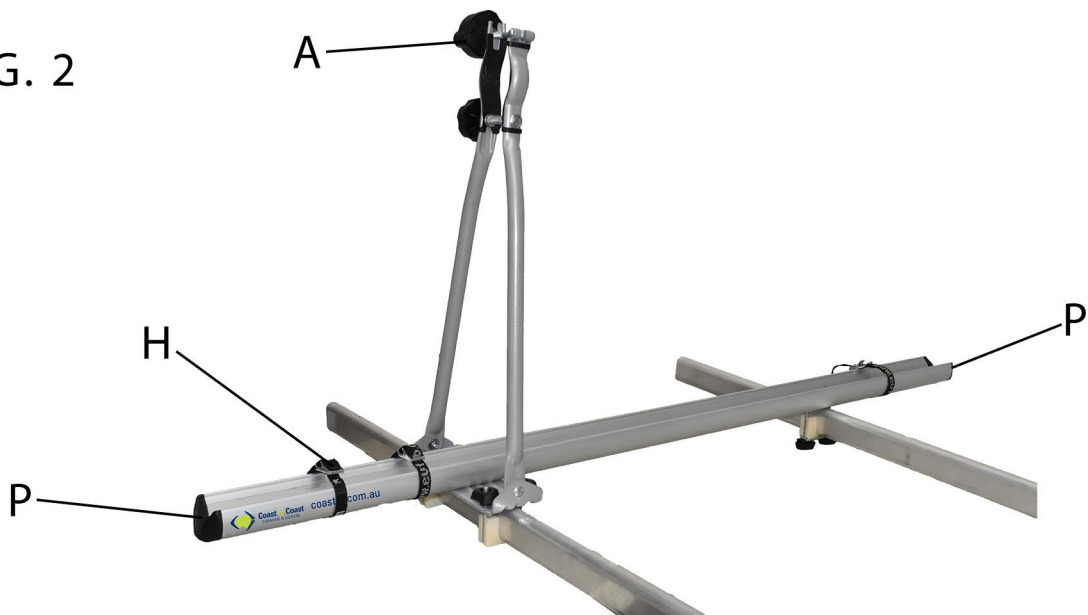











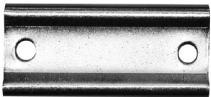

FIG. 3



PART DESCRIPTION	PART INSTALLATION CODE	PART IMAGE		N°
Knurled nut M6	M		6	90176
Toggle screw M8;	A		1	90511
Tension belt, small	H		3	90230
washer M6	L		6	90251
Pressure spring	D		1	90685
Lock screw M8X120	G		1	90686
Belt guide	N		2	90189

ADDITIONAL U-BRACKETS AND T-SLIDE
TO SUIT CAR ROOF RACKS
60W x 55H mm



PART DESCRIPTION	PART INSTALLATION CODE	PART IMAGE		N°
End cap	P		2	90516
U-bracket	U		2	90159
Lower plate	J		1	90160
T Slide	L		1	90687
Knurled nut	B		1	90140

Additional Roof rack accessories such as additional cross bar rails and roof rack baskets are available from your nearest caravan accessories outlet. Visit www.coastrv.com.au to learn more and to find your nearest stockist.

