

ENCLAON

24" LED TV DVD COMBO

Model: LED24X80

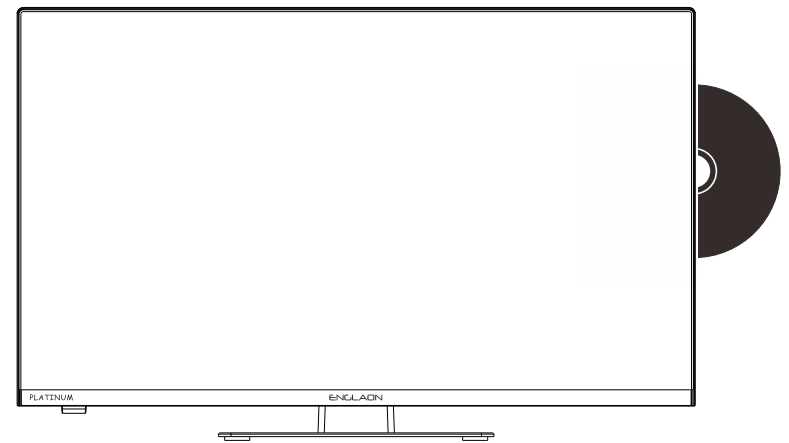

User's Manual

Please Read this manual carefully and retain for future reference

USER'S MANUAL

Safety Information

IMPORTANT SAFETY INSTRUCTIONS

Read these instructions.
Keep these instructions.
Heed all warnings.
Follow all instructions.
Do not use this apparatus near water.
Clean only with dry cloth.
Do not block any ventilation openings. Install in accordance with the manufacturer's instructions.
Do not install near any heat sources such as radiators, heat registers, stoves, or other apparatus (including amplifiers) that produce heat.
Do not defeat the safety purpose of the polarized or grounding plug. A polarized plug has two blades with one wider than the other. A grounding plug has two blades and a third grounding prong. The wide blade or the third prong is provided for your safety. If the provided plug does not fit into your outlet, consult an electrician for replacement of the obsolete outlet.
Protect the power cord from being walked on or pinched particularly at the plugs, convenience receptacles, and at the point where they exit from the apparatus.
Only use attachments/accessories specified by the manufacturer.
Use only with the cart, stand, tripod, bracket, or table specified by the manufacturer, or sold with the apparatus. When a cart or rack is used, use caution when moving the cart/apparatus combination to avoid injury from tip-over.



Unplug the apparatus during lightning storms or when unused for long periods of time.

Refer all servicing to qualified personnel. Servicing is required when the apparatus has been damaged in any way, such as power supply cord or plug is damaged, liquid has been spilled or objects have fallen into the apparatus has been exposed to rain or moisture, does not operate normally, or has been dropped.

CAUTION: These servicing instructions are for use by qualified service personnel only. To reduce the risk of electric shock, do not perform any servicing other than that contained in the operating instructions unless you are qualified to do so.

WARNING : To reduce the risk of fire or electric shock, do not expose this apparatus to rain or moisture. The apparatus shall not be exposed to dripping or splashing and that objects filled with liquids, such as vases, shall not be placed on apparatus.

WARNING: The mains plug is used as disconnect device, the disconnect device shall remain readily operable.



- This lightning flash with arrowhead symbol within an equilateral triangle is intended to alert the user to the presence of non-insulated "dangerous voltage" within the product's enclosure that may be of sufficient magnitude to constitute a risk of electric shock.

- Warning: To reduce the risk of electric shock, do not remove cover (or back) as there are no user-serviceable parts inside. Refer servicing to qualified personnel.
- The exclamation point within an equilateral triangle is intended to alert the user to the presence of important operating and maintenance instructions in the literature accompanying the appliance.

Apparatus with class I construction shall be connected to a mains socket outlet with a protective earthing connection.

Important Safety Precautions

Safety

Please, immediately pull out the AC power plug from adapter if there is an abnormal sound or smell or the LED TV has sound but no picture, and contact after sales support.

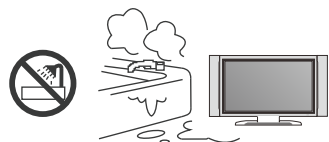

The LED TV should be kept free from rain, moisture and dust to prevent electrical shock and short circuits. Do not cover the ventilation openings with table clothes, curtains, newspapers, etc.

The LED TV should be kept from high temperature heating sources or direct sunlight. Good ventilation is required. Allow 10 cm. between the LED TV and other appliances or built-in cabinet walls.

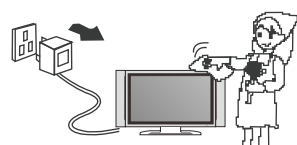
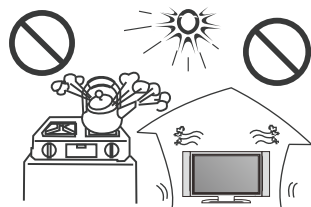

When you wipe the front cabinet, please make sure the power plug is pulled out and use a soft, dry, lint-free cloth and handle it with care. Do not repeatedly wipe the panel, nor scrape, tap or strike the panel with a hard object.

Do not wipe the LED TV with any petrol, chemical or alcohol based solvents as it will lead to product damage of the panel and cabinet.

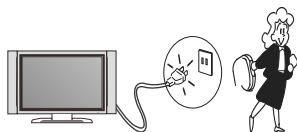
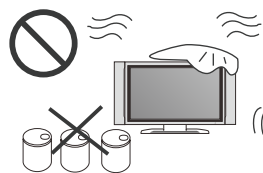

When the television receiver is not used for an extended period of time, it is advisable to disconnect the AC power cord from the AC outlet.

Important Safety Precautions

Safety

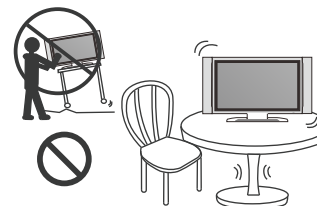

Do not place the LED TV on an unstable surface.

Do not place the power cord or other cables across a walkway in case it is trampled on. Do not overload the power cord or power socket. When the power plug is used to disconnect and connect the device, it should easily go into the power source.

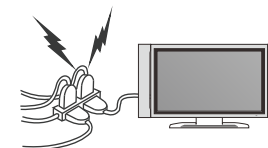

Do not disassemble the back cover, as it contains high voltages inside and will cause electric shock. Only qualified professionals should conduct internal adjustments, maintenance, and checks.

The TV set should not be subjected to water droplets, vapor, or splash. This equipment should not be placed on objects filled with liquids. Do not place flame sources, such as lit candles, on or near the LED TV. Please, pull out the power plug and contact after sales support if there are abnormal objects or water in the TV.

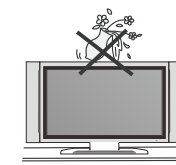

Pull out the power cord and antenna cable during electrical storms so the LED TV is not damaged by electrical surges. Keep all people away from the antenna cable during electrical storms.

Table of Contents

Introduction	
Features	3
Accessories	3
Specifications	4
General Description	5
Overview of front and side panel	5
Overview of back panel	6
Assembling Stand Process	7-9
Overview of remote control	7-9
Installing Batteries in the Remote Control	10
Antenna connection	
External Connection	11-14
Connecting VCR	11
Connecting DVD Player/Set-Top Box via HDMI	12
Connecting DVD Player/Set-Top Box	13
Connecting EARPHONE	14
Supporting signals	14
Basic operation	15
Turning the TV On and Off	15

Table of Contents

OSD Menu Operations	16-27
Main Menu	17-21
Picture	22
Sound	23
Time	24
Lock	25
Option	26
PVR	27
Media Menu Operations	28-29
DVD	30
Troubleshooting	31
Picture defects and the reason	32
Smart TV	33-39

Introduction

Features

Input terminals used for external equipment connection

One AV input
One YPbPr input
One EARPHONE output
One ANTENNA input
Two HDMI input

Two USB input
One Android USB input
One Android RJ45 input

Accessories

Please make sure the following items are included with your LED TV. If any items are missing, contact your dealer.



Remote Control

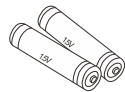

Batteries (AAA x 2)

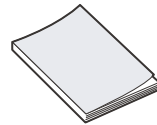

Instructions Manual

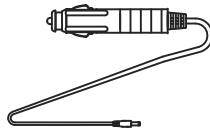

12V/24V Accessory Plug

Introduction

Specifications

Display screen type	Color LED display
Model	LED24X80
The maximum resolution	1920X1080
Power supply	DC 12V \approx 4A
TV system	PAL/DVB-T
Frequency range	48. 25MHz - 863. 25MHz
Video input Format	PAL/NTSC
Antenna input	antenna socket 75 Ω
Average Power Consumption	36W
Dimensions (LXWXH)	21.3 x 4.9 x 13.6 inch
Weight (Net weight)	3.7 Kg
Operation environment temperature	0 $^{\circ}$ C-35 $^{\circ}$ C

Remarks:

The above listed specifications and data are subject to change without prior notice.

General Description

Overview of front and side panel

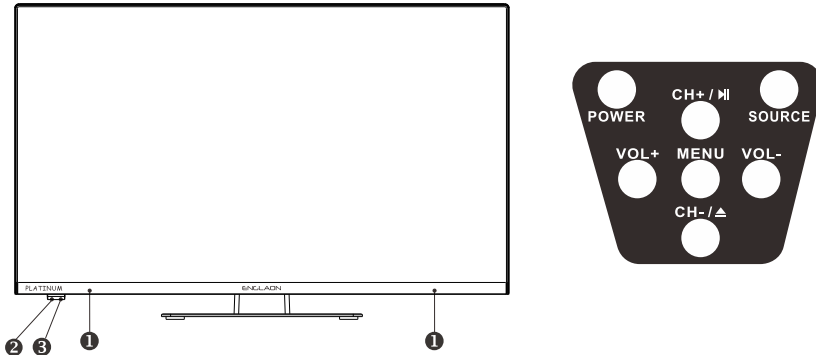

- | | |
|--|--|
| <p>1 SPEAKER</p> <p>2 REMOTE CONTROL SENSOR</p> <p>3 POWER INDICATOR
Green: In power on mode.
Red: In standby mode.</p> <p>4 SOURCE
Toggles between all the available input sources</p> <p>5 MENU
Press to see an on-screen menu of your TV's features.</p> <p>6 CH+/-
Press to change channels.
In the on-screen menu, use the CH +/- buttons as up/down arrow buttons.</p> | <p>7 VOL+/-
Press to increase or decrease the volume.
In the on-screen menu, use the VOL +/- buttons as left/right arrow buttons.</p> <p>8 PLAY
Play/stop DVD (in DVD mode).</p> <p>9 EJECT
Eject DVD.</p> <p>10 POWER
Press POWER button to toggle between normal and standby mode.</p> |
|--|--|

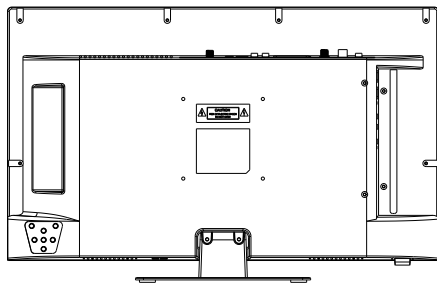

General Description

Overview of back panel

Side port



Port

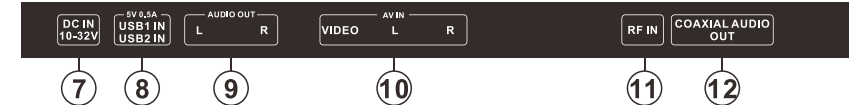

- | | |
|---|---|
| <p>1. Android USB
External device interface.</p> <p>2. Android RJ45
Ethernet connection for.</p> <p>3. EARPHONE
Connecting for headphone.</p> <p>4. YPbPr
Connecting for the Y/Pb/Pr Input in Component mode.</p> <p>5. IN HDMI2
Connecting for HDMI signal.</p> <p>6. IN HDMI1
Connecting for HDMI signal.</p> | <p>7. DC IN 10-32V
DC input</p> <p>8. USB1 / USB2 IN
5V 0.5A</p> <p>9. L/R
Connect to the audio output jacks on your amplifier/home theater.</p> <p>10. VIDEO
Connecting for VIDEO signal input in Composite mode.</p> <p>11. RF
Connected to external antenna to receive the ATV/DTV program in ATV/DTV mode.</p> <p>12. COAXIAL
Coaxial Digital audio output.</p> |
|---|---|

Assembling Stand Process

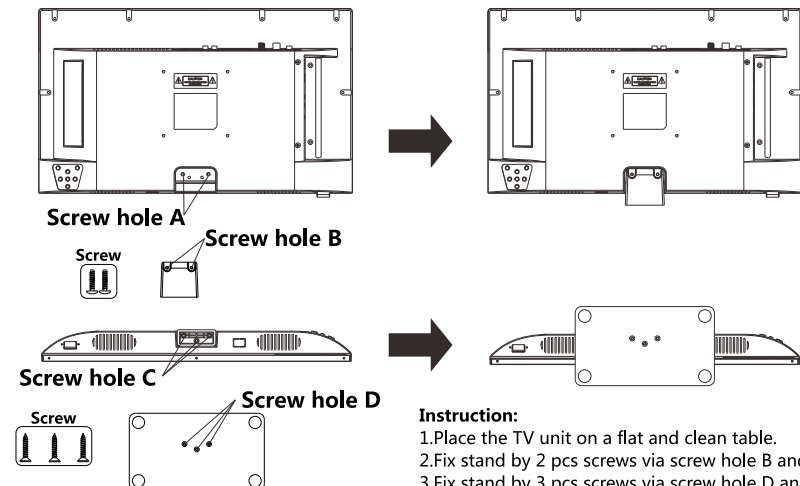

- Instruction:**
- Place the TV unit on a flat and clean table.
 - Fix stand by 2 pcs screws via screw hole B and A.
 - Fix stand by 3 pcs screws via screw hole D and C.

General Description

Overview of remote control

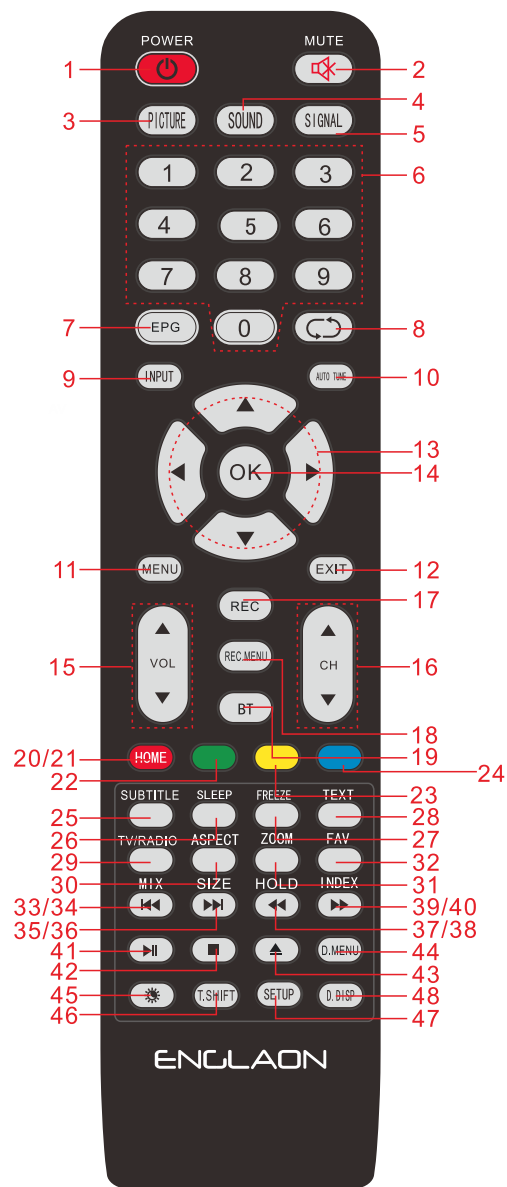

General Description

Overview of remote control

No.	Button	Description
1	POWER	Turns the TV on or off to standby mode.
2	MUTE	Press to mute the sound. Press again to regain sound.
3	PICTURE	Select the picture mode.
4	SOUND	Select the sound mode.
5	SIGNAL	The signal model.
6	0-9	Press 0-9 to select a TV channel directly. The channel will change after 2 seconds.
7	EPG	Press to display EPG (Electronic Program Guide).
8	↺	Return to the previously viewed program.
9	INPUT	Press to select signal the source for the TV.
10	AUTO TUNE	Automatic searching.
11	MENU	Allows you to navigate the on screen menus (OSD).
12	EXIT	Exit from the current menu or sub-menu.
13	◀▶ ▲▼	Allows you to navigate the on-screen menus and adjust the system settings to your preference.
14	OK	Select the option.
15	VOL+/-	Press these two buttons to increase/decrease the volume.
16	CH+/-	Press these two buttons to change channels up/down.
17	REC	Press to record the program immediately.
18	REC MENU	Press to switch to REC.MENU immediately.
19	BT	Bluetooth Shortcut Key for TV Set.
20	HOME	Android home screen.
21	R (DELETE)	Delete function button.
22	G (RENAME)	Rename function button.
23	Y (MOVE)	Move function button.
24	B (SKIP)	Skip function button.
25	SUBTITLE	Press to select the subtitle language.
26	SLEEP	Set the delay time for the TV to turn off automatically.
27	FREEZE	Freeze key.
28	TEXT	Switch on/off of Teletext window.
29	TV/RADIO	Press to switch between DTV and radio programs
30	ASPECT	Press this button to select the aspect ratio of the screen.
31	ZOOM	Zoom In or Out of the window.
32	FAV	Selects favorite channel(s).
33	◀◀	Plays the previous Media Player or DVD file/chapter.
34	MIX	Sets the transparency of Teletext window.
35	▶▶	Plays the next Media Player or DVD file/chapter..
36	SIZE	Zoom In or Out of the Teletext window.
37	◀◀	Fast Rewind Media-Player and DVD.
38	HOLD	Holds on the current Teletext page.
39	▶▶	Fast Forward Media-Player and DVD.

General Description

Overview of remote control

No.	Button	Description
40	INDEX	Returns to Index page by Teletext.
41	▶	Play and Pause Media-Player / DVD.
42	■	Stops playback Media-Player and DVD.
43	▲	Eject/insert disc.
44	D.MENU	Quick Teletext navigation or setup settings / DVD: Video DVD Menu button.
45	☀	Brightness control.
46	T.SHIFT	Press to switch to TIME SHIFT mode immediately.
47	SETUP	DVD system setup.
48	D.DISP	Quick navigation during Teletext or setup settings / DVD: DVD Information button.

General Description

Installing Batteries in the Remote Control

Installing Batteries

- 1 Open the battery compartment cover on the back side.

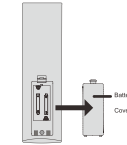

- 2 Insert two 1.5V AAA size batteries in correct polarity. Don't mix old or used batteries with new ones.

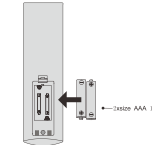

- 3 Closed the cover.

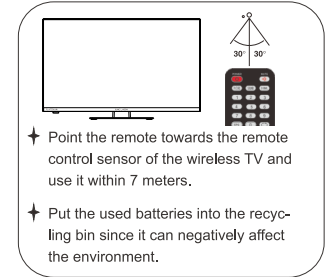
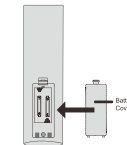

Note:

- One loading of batteries will last for 1 year under normal use
- If you do not intend to use the remote controller for a long period of time, remove them to avoid damage due to leakage.
- Do not use old and new batteries together.
- The battery (battery or batteries or battery pack) shall not be exposed to excessive heat such as sunshine, fire or the like.

External Connection

Antenna connection

Antenna input impedance of this unit is 75ohm. VHF/UHF 75ohm coaxial cable can be connected to the antenna jack directly, if the antenna cable is 300ohm parallel flat feeder cable, you need to use the 300ohm/75ohm converter to connect the antenna cable to the antenna jack. For details Please refer to the following drawing.

Antennas with 300ohm flat twins Leads

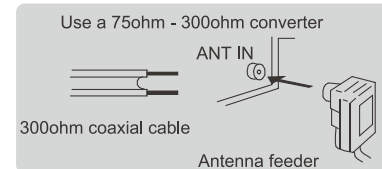

Antennas with 75ohm Round Leads

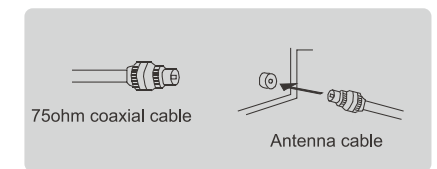

External Connection

Connecting VCR

These instructions assume that you have already connected your TV to an antenna or a cable TV system. Skip step 1 if you have not yet connected to an antenna or a cable system.

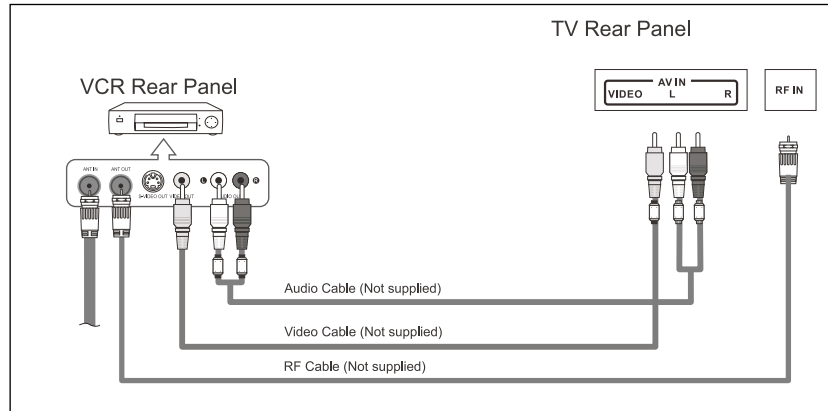

Follow the instructions in Viewing a VCR or Camcorder Tape to view your VCR tape. Each VCR has a different back panel configuration. When connecting a VCR, match the color of the connection terminal to the cable. We recommend the use of cables with a Ferrite Core.

1. Unplug the cable or antenna from the back of the TV.
2. Connect the cable or antenna to the ANT IN terminal on the back of the VCR.
3. Connect an RF Cable between the ANT OUT terminal on the VCR and the ANT IN terminal on the TV.
4. Connect a Video Cable between the VIDEO OUT jack on the VCR and the VIDEO IN jack on the TV.
5. Connect Audio Cables between the AUDIO OUT jacks on the VCR and the AUDIO L and AUDIO R jacks on the TV.
 - If you have a mono (non-stereo) VCR, use a Y-connector (not supplied) to hook up to the right and left audio input jacks of the TV. If your VCR is stereo, you must connect two cables.

External Connection

Connecting DVD Player/Set-Top Box via HDMI

This connection can only be made if there is a HDMI Output connector on the external device.

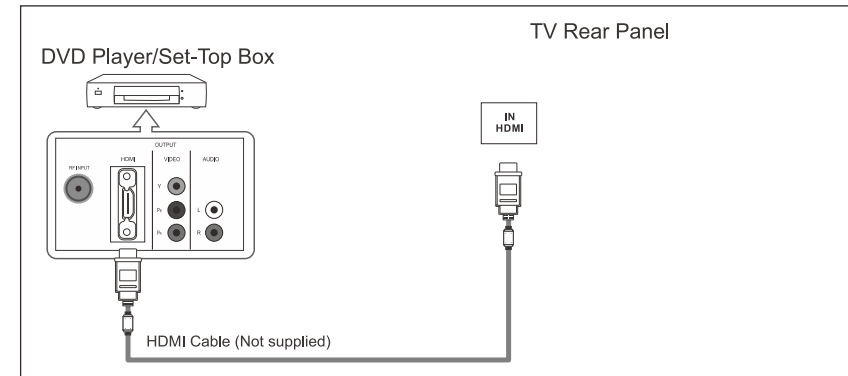

What is HDMI?

HDMI, or high-definition multimedia interface, is a next-generation interface that enables the transmission of digital audio and video signals using a single cable without compression.

Multimedia interface is a more accurate name for it especially because it allows multiple channels of digital audio (5.1 channels).

The difference between HDMI and DVI is that the HDMI device is smaller in size, has the HDCP(High Bandwidth Digital Copy Protection) coding feature installed, and supports multi-channel digital audio.

Each DVD player/STB has a different back panel configuration.

We recommend the use of cables with a Ferrite Core.

1. Connect an HDMI Cable between the HDMI connector on the TV and the HDMI connector on the DVD player/Set-Top Box.

External Connection

Connecting DVD Player/Set-Top Box

The rear panel jacks on your TV make it easy to connect a DVD to your TV.

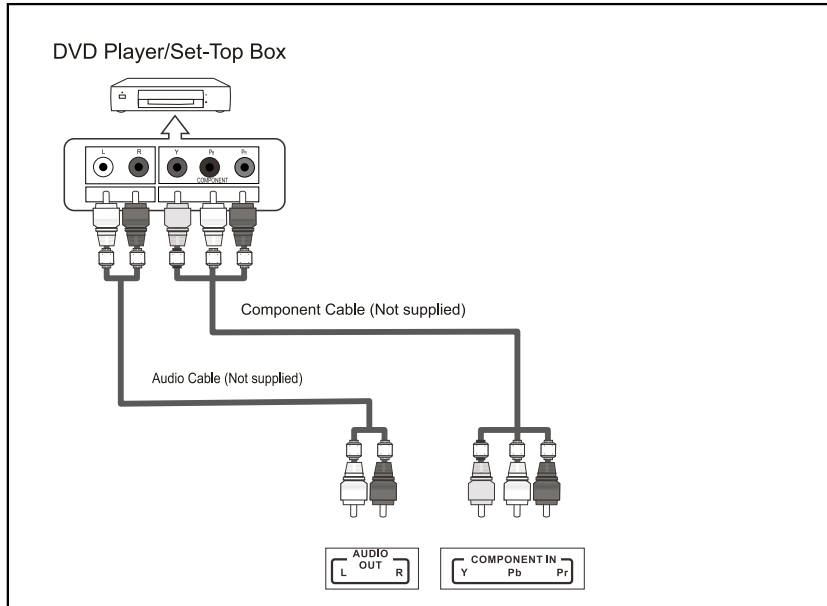

Component video separates the video into Y (Luminance (brightness)), Pb (Blue) and Pr (Red) for enhanced video quality.

Be sure to match the component video and audio connections.

For example, if connecting the video cable to COMPONENT IN, connect the audio cable to COMPONENT IN also.

Each DVD player/STB has a different back panel configuration.

When connecting a DVD player/STB, match the color of the connection terminal to the cable.

We recommend the use of cables with a Ferrite Core.

1. Connect a Component Cable between the COMPONENT IN [Y, PB, PR] jacks on the TV and the COMPONENT [Y, PB, PR] jacks on the DVD player.
2. Connect Audio Cables between the COMPONENT IN [R-AUDIO-L] jacks on the TV and the AUDIO OUT jacks on the DVD player.

External Connection

Connecting EARPHONE



1. Plug EARPHONE out connector into EARPHONE out jack on the TV the TV speaker will be muted.

Supporting signals

Input	Resolution	VerticalFrequency
Component	480p	60Hz
	720p	60Hz
	1080i	60Hz
HDMI	1080p	60Hz
	480p	60Hz
	720p	60Hz
	1080i	60Hz
	1080p	60Hz

Input	Resolution	VerticalFrequency
PC/VGA	640x480	60Hz
	800X600	60Hz
	1024X768	60Hz
	1360X768	60Hz
	1920X1080	60Hz

Basic Operation

Turning the TV On and Off

How to turn the TV on or off

1. Insert the power cord plug into a polarized DC outlet.
2. Press **POWER** button on the remote control or **⏻** button on the LED TV.
3. Normal picture will be displayed on the screen after 6 seconds. If no signal input, "No Signal" will be displayed on the screen.
4. If temporary POWER off is required, press **POWER** button on the remote control or **⏻** button on the LED TV.
5. If you want to completely switch off the power for this unit, unplug the power cord plug for this unit.
6. After switching off the unit, you should turn on the TV again at least 5 seconds later.

Status indication lamp

Green: In power on mode.

Red: In standby mode.

Auto power-off

If there is no signal input in any Mode, the TV will automatically access the standby state in about 15 minutes.

Memory before turning TV off

The settings of picture and the preset channels will be memorized at turning off the unit. When being started up again, the unit will work according to the mode set before being turned off.

OSD Menu Operations

Step one: It shows "OSD Language" for you to choose when boot for the first time

Step two: enter "Country" menu

Step three: Enter "Energy" menu

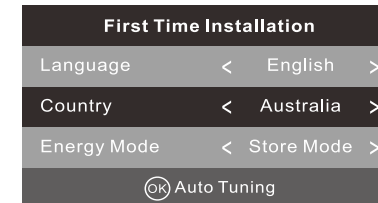

Enter "Tune Type" menu

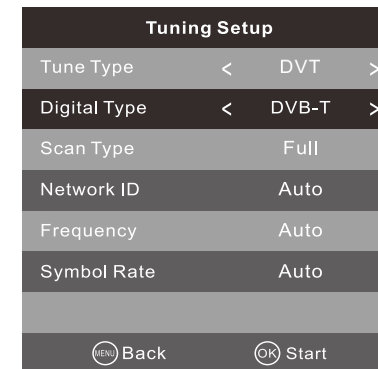

Input Source

There is 9 ports at most in Input Source menu page. It supports DTV/ATV/DVD/AV/YPbPr/SMART TV/HDMI1/HDMI2/USB.

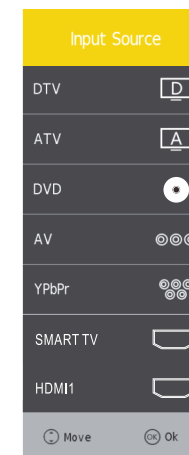

OSD Menu Operations

Adjust the OSD Screen

Main Menu

Press [MENU] key to show main menu, there are five functions under main menu, they are Channel, Input Source, Application, Media Play, Setting, Press [LEFT]/[RIGHT] to select these functions.

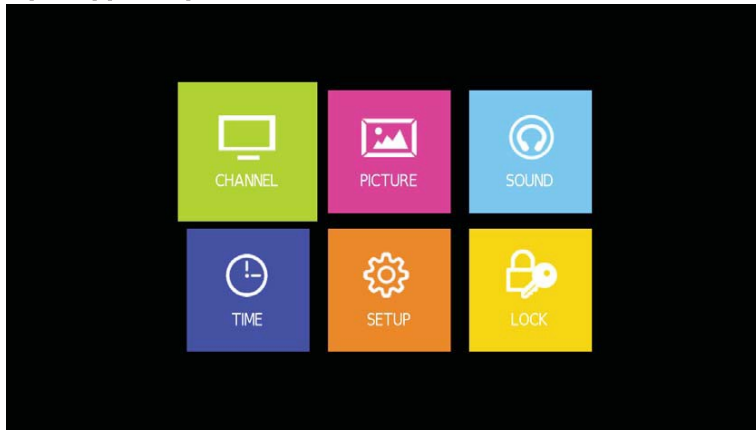

Channel

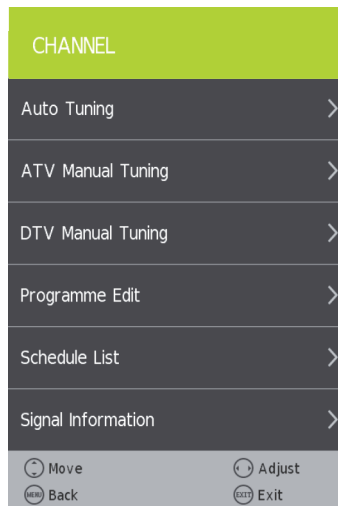

OSD Menu Operations

Adjust the OSD Screen

Main Menu

Auto Tuning

Under the Auto Tuning of CHANNEL menu, Press [LEFT]/[RIGHT]/[OK] key to enter Auto Tuning, the following prompt box will appear.

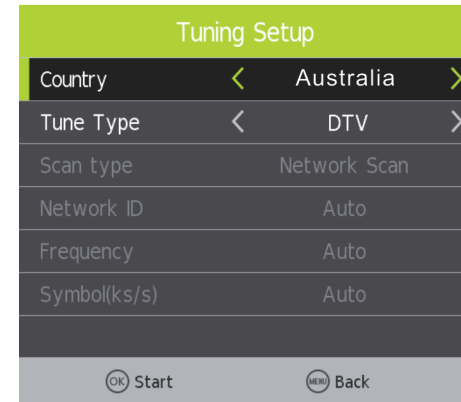

When Tune Type is DTV+ATV, press OK key to enter DTV auto searching.

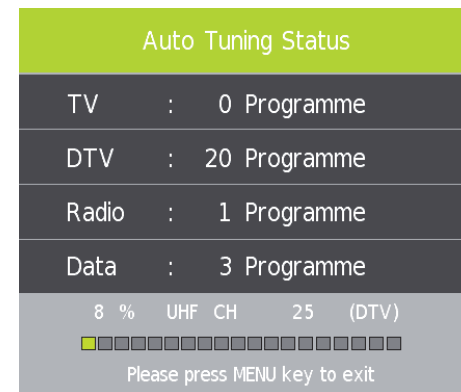

OSD Menu Operations

Adjust the OSD Screen

Main Menu

When search DTV, if you want to skip ATV and directly enter DTV, press MENU to enter the menu as follows:

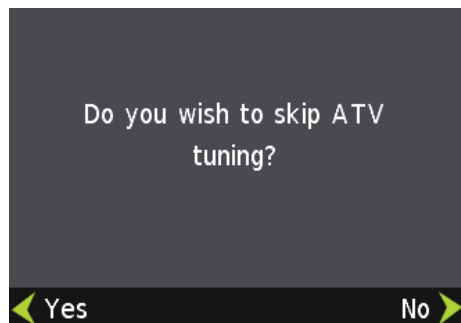

Press left/right key to select Yes/No, Press OK to execute. "Yes" is to skip the ATV searching and enter DTV searching. When searching, if you want to directly exit from searching, press EXIT to exit.

ATV Manual Tuning

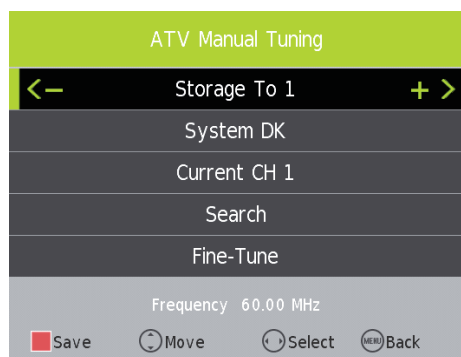

Press [LEFT]/[RIGHT] to adjust channels, when there is signal, press OK then begin ATV searching.

Tips: After searching the channel manually, do press red key to save the channels, or, after you switch the status, the channel you searched won't be saved.

OSD Menu Operations

Adjust the OSD Screen

Main Menu

DTV Manual Tuning

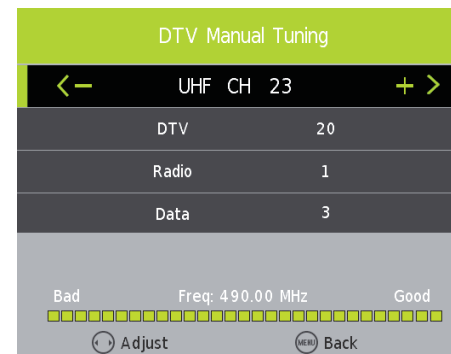

Press [LEFT]/[RIGHT] to adjust channels, when there is signal, press OK then begin DTV searching.

Program Edit

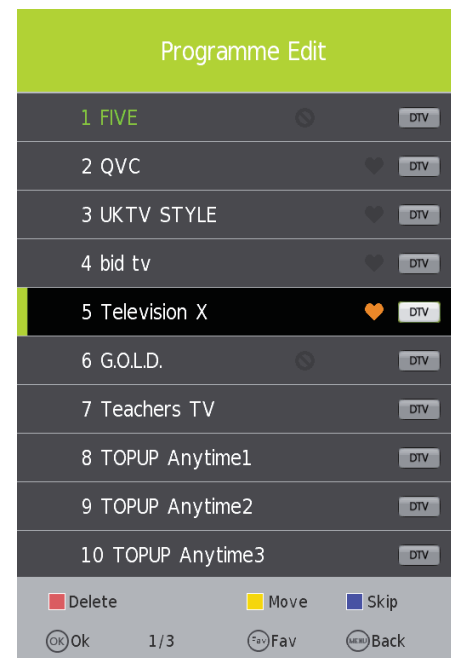

OSD Menu Operations

Adjust the OSD Screen

Main Menu

Channel edit function includes "Delete/Move/Rename/Skip/Fav". Fav/Skip mark will appear only after the users have some setting on the channel(Fav and Ship can't be set together).

■ **Delete:** Press [RED] key to cancel the program that the cursor is in.

■ **Move:** Press [YELLOW] key, according to the prompt, execute MOVE function, move the program order.

■ **Skip:** Press [BLUE] key, the program the cursor is will be marked with SKIP. When execute CH+/CH-, skip this program, and this program can't be selected even press the number key.

■ **Rename:** Rename function only appear and can be used under ATV program. Press [GREEN] key under ATV, the program can be renamed.

■ **Favorite:** Press [FAV] key, mark the program the cursor is in as favorite program.

PVR

In CHANNEL menu, under PVR File system option, Press [LEFT]/[RIGHT]/[OK] key to enter PVR menu, as follows:



OSD Menu Operations

Adjust the OSD Screen

Picture

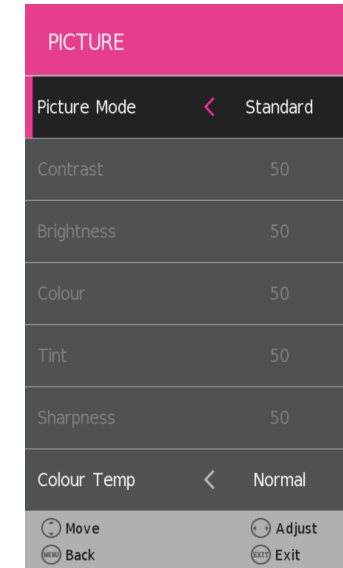

Picture Mode

Standard->Mild->Dynamic->User->EC O Home,Picture mode selection.

Color Temperature

Standard-> Cool -> Warm -> UserColorTemperature selection

Noise Reduction

Off->Low->Middle->High-> AutoNoise reduction; it is under Hide status under VGA.

OSD Menu Operations

Adjust the OSD Screen

Sound

Sound Mode

Press [UP]/[DOWN] button to select Location, and then Press [LEFT]/[RIGHT] button to select, then press OK button to confirm.

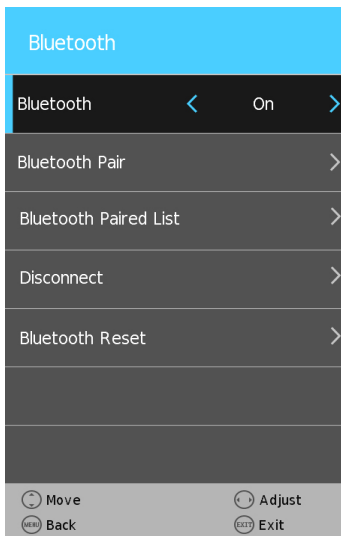
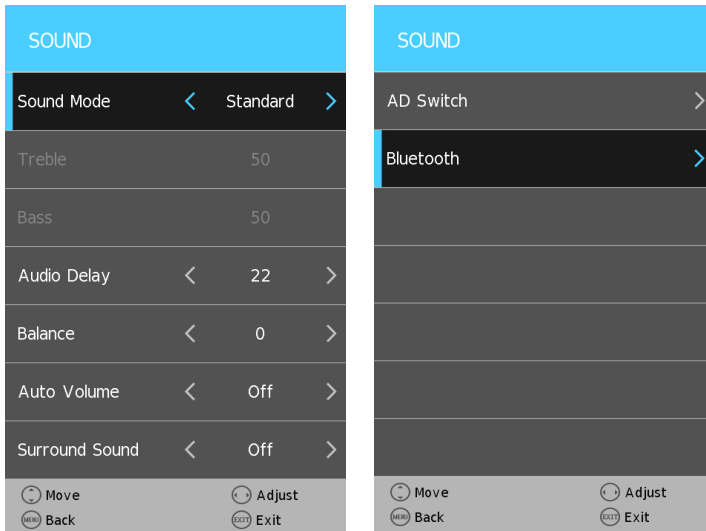

Bluetooth (on/off) : Bluetooth (on/off)
Bluetooth Pair: Press ► button on remote control, it will search the Bluetooth soundbar directly.

Bluetooth Paired List: Press OK button on remote control to view the name of the Bluetooth soundbar device that has been searched

Disconnect: Press ► button on remote control to disconnect the Bluetooth soundbar.

Bluetooth Reset: Press ► button on remote control, Bluetooth will reset.

OSD Menu Operations

Adjust the OSD Screen

Time

Time Mode

Press [UP]/[DOWN] button to select Location, and then Press [LEFT]/[RIGHT] button to select, then press OK button to confirm.

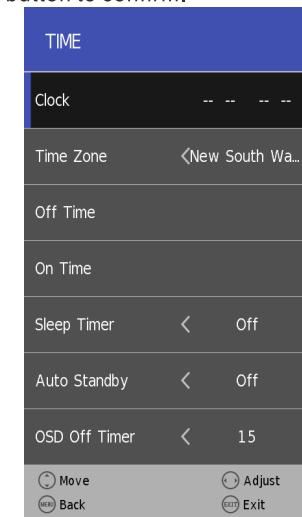

OSD Menu Operations

Adjust the OSD Screen

Lock

Lock Mode

Press [UP]/[DOWN] button to select Location, and then Press [LEFT]/[RIGHT] button to select, then press OK button to confirm.

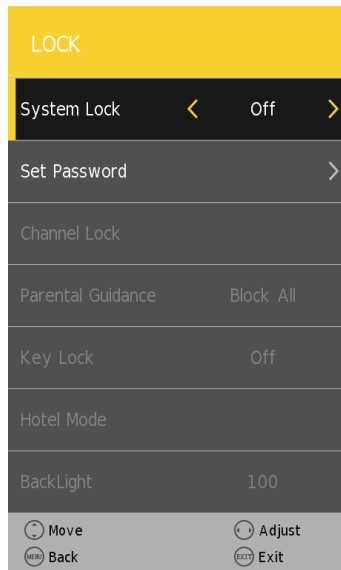

OSD Menu Operations

Adjust the OSD Screen

Option

Lock Mode

Press [UP]/[DOWN] button to select Location, and then Press [LEFT]/[RIGHT] button to select, then press OK button to confirm.

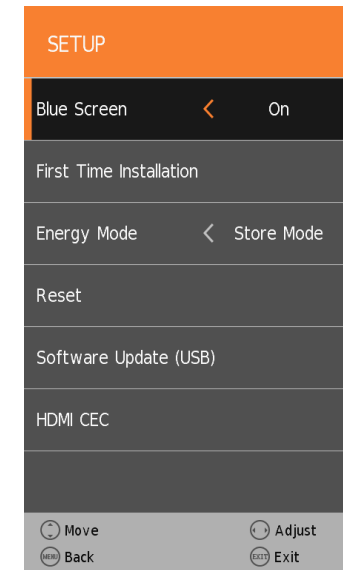

OSD Menu Operations

Adjust the OSD Screen

PVR

PVR

Record

In DTV, press [REC] button, it will display the following menu below, and start to burn the current DTV program. Press [LEFT]/[RIGHT] button to move cursor to exercise different function according to hint.

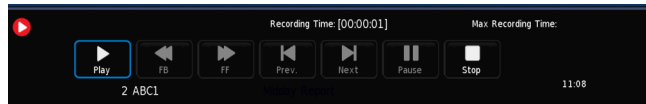

Playback

After burning the program, exit from Record, press [PLAY] button to implement Playback function. Different function can be implemented according to hint.

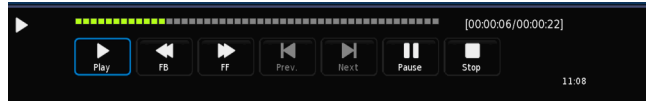

Timeshift

In DTV, press [PLAY/PAUSE] button to implement the function of Timeshift. Press [LEFT]/[RIGHT] button to move cursor to exercise different function according to hint.

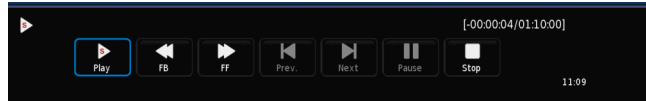

Media Menu Operations

Media

Media Player

In the option of Media Player on MainMenu, Press [OK] to enter the Media Player menu, see the picture as follows: Press [LEFT]/[RIGHT] to select Movie, Music or Photo.

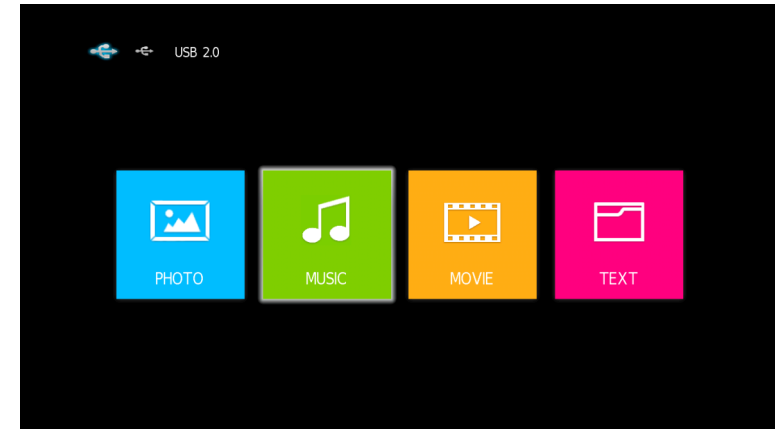

Take Movie function for example, when there is focus point on Movie function, press [OK] button to enter into File Selector menu.

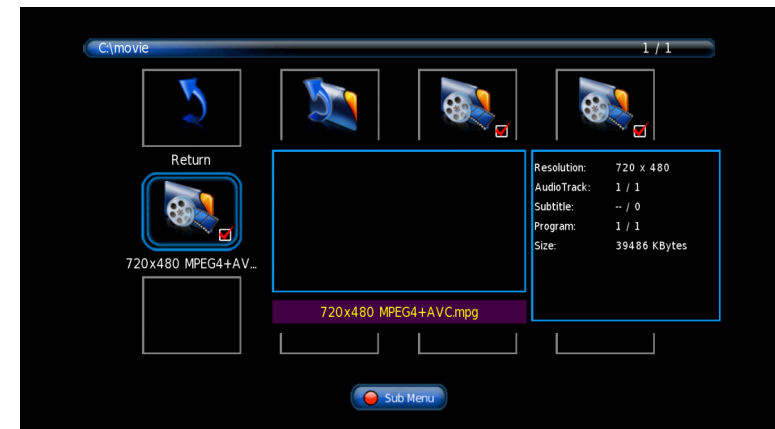

On FileSelector menu, select film source that needs to be play according to the hint. Press [PLAY/PAUSE] button to enter into the play mode of full screen; press [PLAY/PAUSE] to return to Media Player menu.

OSD Menu Operations

Media

Media Player

Movie

on Media Player menu, move cursor to movie, press [OK] button to enter into FileSelector menu. Select the file you want to play, press [PLAY/PAUSE] to enter into full screen play. Press [LEFT]/[RIGHT] button to move cursor, and operate according to different hint.

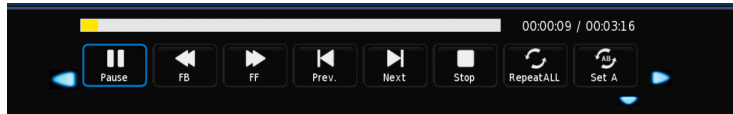

Music

In the same way, on Media Player menu, move cursor to Music, press [OK] button to enter into FileSelector menu. Select the file you want to play, press [PLAY/PAUSE] to enter into full screen play. Press [LEFT]/[RIGHT] button to move cursor, and operate according to different hint.



Photo

In the same way, on Media Player menu, move cursor to Photo, press [OK] button to enter into FileSelector menu. Select the file you want to play, press [PLAY/PAUSE] to enter into full screen play. Press [LEFT]/[RIGHT] button to move cursor, and operate according to different hint.

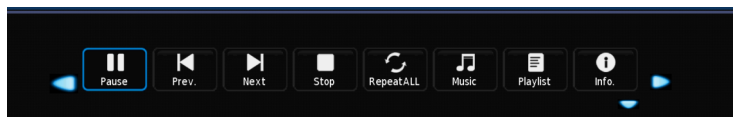

DVD

INITIAL SETTINGS (DVD)

General Settings page

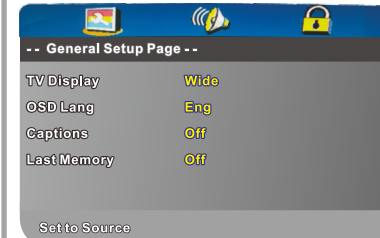

1. TV DISPLAY: Set the screen ratio options are: Normal/PS (4:3 Pan Scan), Normal/PS (4:3 Letter Box) and Wide (16:9). The default settings is wide.
2. OSD Lang: Set the OSD Language options.
3. CAPTION: Play captions on supported DVD titles, Options: ON/OFF.
4. LAST MEMORY: Play DVD from last point. Options are: ON/OFF.

Audio Setup Page

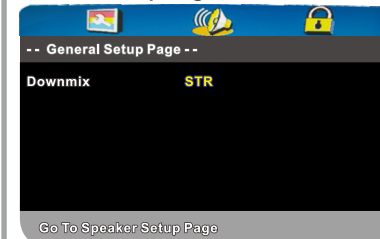

1. LT/RT: Logic Surround stereo audio output, This matrix-based coding process enables stereo audio tracks to carry four channels (left, center, right and surround) of audio data.
2. Stereo: Analog stereo audio output. The player sends the subwoofer and speech signals to the TV's speakers.

Preference Page



1. TV Type: The DVD player supports output of various systems including Multi, NTSC, PAL. The default setting is PAL and this should not need to be changed.
2. Audio: DVD language selection options.
3. Subtitle: This player can display DVD subtitle languages if supported by the DVD disc. When playing DVD's, you can hide the subtitle or choose any of them as the current subtitle language.
4. Disc menu: DVD Disc menu language selection options.
5. PARENTAL This function disables playback of specific DVD's which may be unsuitable for children. Some DVDs are encoded with specific rating levels. If the rating level of the disc is higher than that preset in this menu, playback of the disc will be prohibited. After selecting one of the PARENTAL codes, the screen will display the PASSWORD page. The default password is "8888".
6. PASSWORD [DVD only]: Allows you to change the current PASSWORD.
7. Default: This option will return the DVD to it's factory default settings.

Troubleshooting

If you have any problem, check the countermeasures for each symptom listed below. The following symptoms may have caused by inappropriate adjustment rather than actual malfunction of the unit. If the trouble persists, contact the service center.

Symptoms	Possible solutions
No power	Disconnect the power cord, wait 60 seconds then reconnect the power cord and restart the TV.
No picture	Check antenna connection. Station may experience problems, please tune to another station. Please adjust the settings of contrast and brightness.
Good picture but no sound	Increase the volume. please check sound settings.
Good sound but abnormal color or no picture	Check the antenna connection.
No remote control	No support for this function.
Full screen flickering under VGA	V-HEIGHT value may be set too big, restart computer and enter safe mode, then set monitor parameters to correct value according to adjustment description.
Horizontal stripes under VGA	Sample phase may be deflected, adjust phase according to picture position.
Colored dots may be present on the screen	This product is the high resolution LED display device and a few cell defects can occur in the manufacture of the LED. Several colored dots visible on the screen would be acceptable. in line with other LED manufacturers and would not mean that the LED is faulty. We hope you will understand that it could not be changed or refunded.

Picture defects and the reason



Snowy Picture

Snowy picture is usually due to weak signal. Adjust antenna or install an antenna amplifier.



Double Image or Ghosts

Double images are usually caused by reflections from tall buildings. Adjust the direction of the antenna or raise it.



Radio Wave Interference

Wave patterns are moving on the screen, which are usually caused by nearby radio transmitters or short-wave receiving equipment.



High Temperature Electrothermal Interference

Diagonal or herringbone patterns appear on the screen or part of picture is missing. This is probably caused by high temperature electrothermal equipment in a nearby hospital.

Quick Guide

ENGLAON

Android TV

OSD Menu Operations

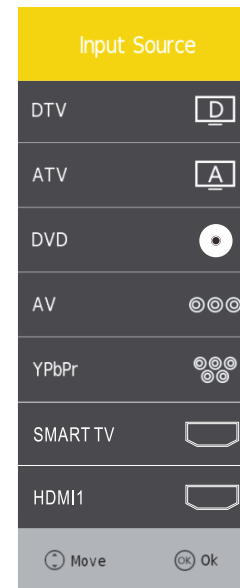

Press SOURCE button to display the input source list.
Press ▼/▲ button to select the input source you want to watch.
Press ENTER button to enter the input source.

Remote Control

RemoteController

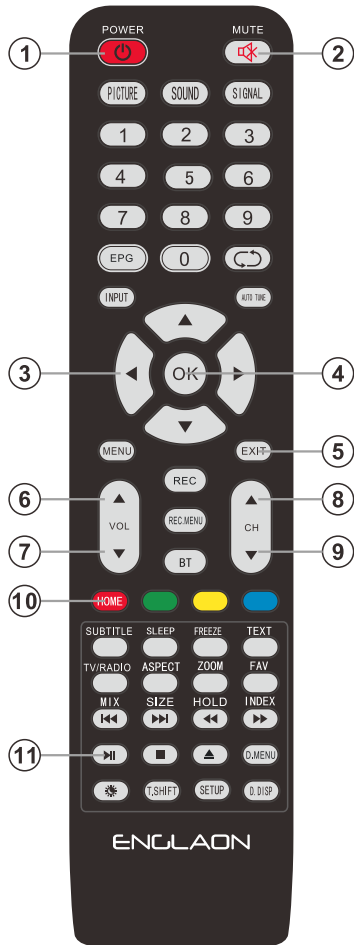

- ① Power
- ② Mute
- ③ Directional Buttons
- ④ OK/Confirm
- ⑤ Return/Back
- ⑥ Vol+
- ⑦ Vol-
- ⑧ Page Up
- ⑨ Page Down
- ⑩ Home
- ⑪ Play/Pause

How to install

Side Panel for Android TV



- 1 . USB for Android TV only.

First Time Usage

Power Up

After power up, starting with Android TV boot animation.



First Time Usage

Setup Wizard- System Language

For first time usage, you will enter the setup wizard. Setup wizard will help you quickly setup Smart TV. First you should select a system language.

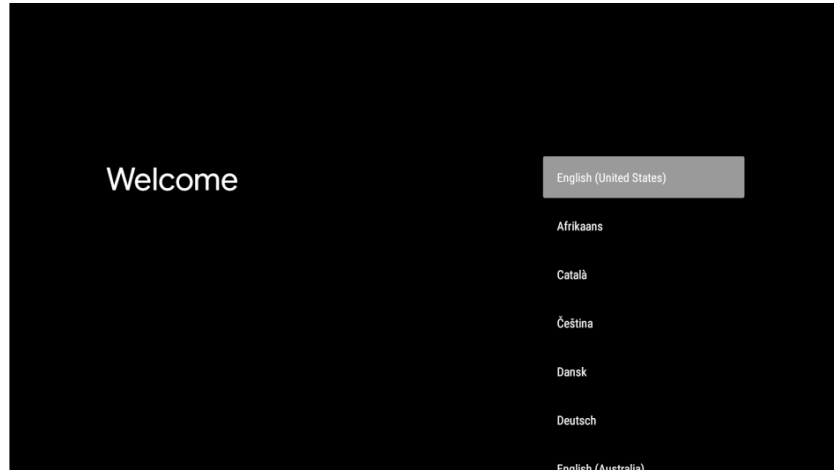

Quickly Setup your TV Android phone or tablet

You can easily setup Smart TV if you have an Android phone or tablet, or you can select Skip to continue the setup.

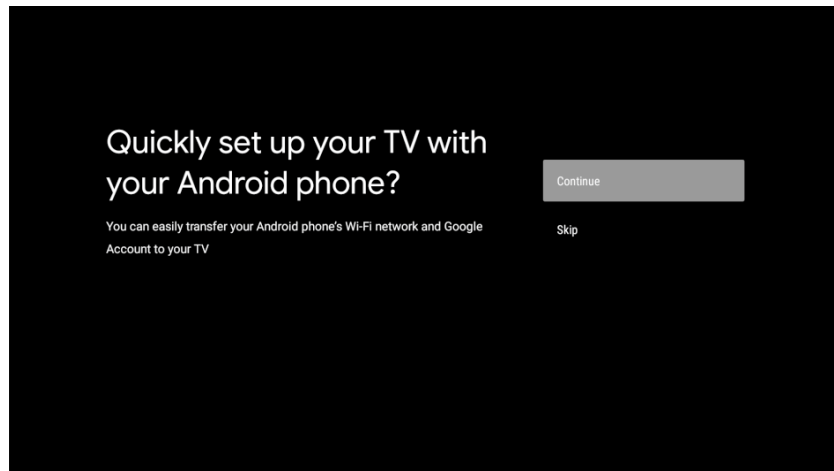

First Time Usage

Setup Wizard- Wi-Fi Setup

Here you can connect Smart TV to your home Wi-Fi router. If your home Wi-Fi router requires password, you will need to enter the correct password.

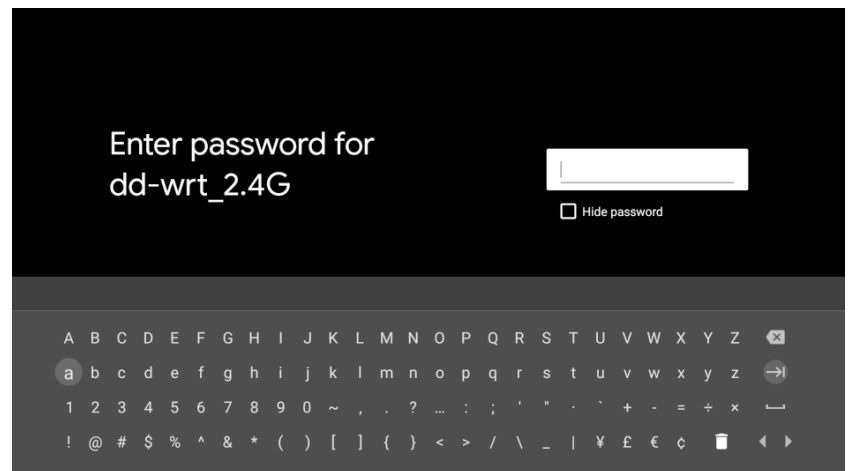
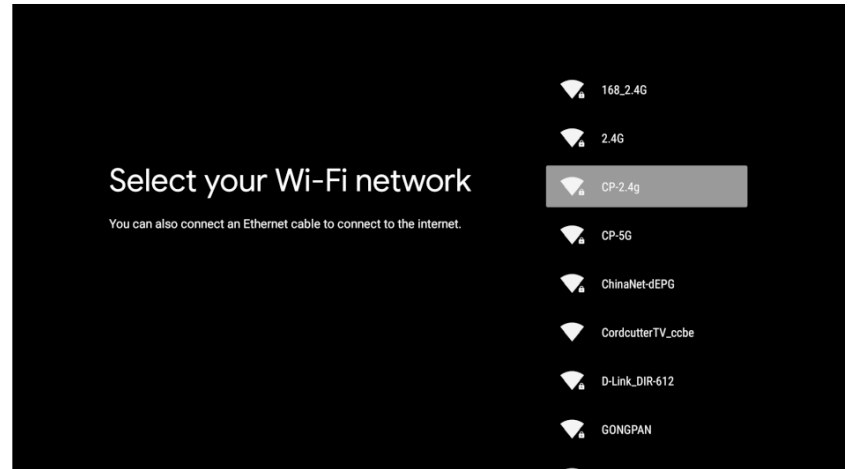

FAQ's

- a) **How to register the Android TV box?**
A welcome screen will appear after switching on the Android TV box for the first time. Using a google account registration is made easy following step-by-step instructions.
- b) **How to install applications?**
Many applications such as, media player, file manager and games are available on the Google Play Store. Choose the application you want and click to install.

Specifications

Model:	ENGTVGBOX
CPU:	Amlogic S905X (Quad-core Cortex A53@ up to 2.0GHz)
Memory:	2GB
Flash memory:	8GB
OS	Android TV OS
WiFi	802.11b/g/n/ac 2.4G and 5G