



Find Your Energy Freedom™



# Renogy

## Solar Panel Installation and Maintenance Manual



# Table of Contents

<b>1. Introduction .....</b>	<b>1</b>
<b>2. Statutes and regulations .....</b>	<b>1</b>
<b>3. General Information .....</b>	<b>2</b>
3.1. Solar Panel Identification .....	2
3.2. Junction box style and wiring method .....	3
3.3. General Safety .....	5
3.5. Operation Safety .....	6
3.6. Fire Protection and Safety .....	7
<b>4. Renogy solar panels installation method.....</b>	<b>8</b>
4.1. Installation location and environment .....	8
4.2. Selection of inclination angle .....	8
<b>5. Renogy solar panels installation - Mechanical installation .....</b>	<b>10</b>
5.1. General Requirements .....	10
5.2. Mechanical mounting of single-sided & double-sided components.....	10
5.3. Introduction of flexible module installation method .....	12
<b>6. Renogy solar panels installation - Electrical installation .....</b>	<b>15</b>
6.1. Electrical parameters.....	15
6.2. Cable and Wiring.....	15
6.3. Connector.....	16
6.4. Bypass Diode .....	16
<b>7. Renogy solar panels installation - Grounding .....</b>	<b>17</b>
<b>8. Renogy solar panels installation - Operation and maintenance ...</b>	<b>18</b>
8.1. Solar panel cleaning .....	18
8.2. Visual Inspection of PV Panels.....	18
8.3. Inspection of the Connector and the Cable .....	19
<b>9. Schedule - Renogy solar panel iteration/mix recommendation ..</b>	<b>20</b>

## 1. Introduction

First of all, thank you very much for choosing Renogy's solar panels!

What should you do with Renogy solar panel installation and maintenance? This guide has covered everything from solar panel installation to cleaning.

This guide contains important electrical and mechanical installation information that you should first understand before you install the components. In addition, the manual contains some other safety information that you must be familiar with. Everything in this manual is the result of a long process of technical exploration and experience

Failure to follow the requirements outlined in this manual may void the limited warranty provided to the customer for the installation of the components. The recommendations in this manual are designed to improve the safety of the modules during installation and have been tested and proven. Please provide this manual to the owner of the PV system for their reference and inform them of all relevant safety, operational and maintenance requirements and recommendations.



## 2. Statutes and regulations

The mechanical and electrical installation of PV modules should refer to the appropriate regulations, including electrical code, building code and electrical connection requirements. These regulations vary depending on the location of the installation, e.g., building rooftop installation, vehicle-mounted applications, etc. Requirements may also vary with the voltage of the installation system, the nature of the current (DC or AC). Please contact your local authority for specific terms.

### 3. General Information

#### 3.1. Solar Panel Identification

**Nameplate:** Type, power rating under standard test conditions, current rating, voltage rating, open circuit voltage, short circuit current, certification mark, maximum system voltage information.

**Serial Number:** Each component has a unique serial number. This serial number is printed on a barcode, placed in the component prior to lamination, and cannot be torn or smeared after lamination. In addition, an identical serial number can be found above or next to the component nameplate.

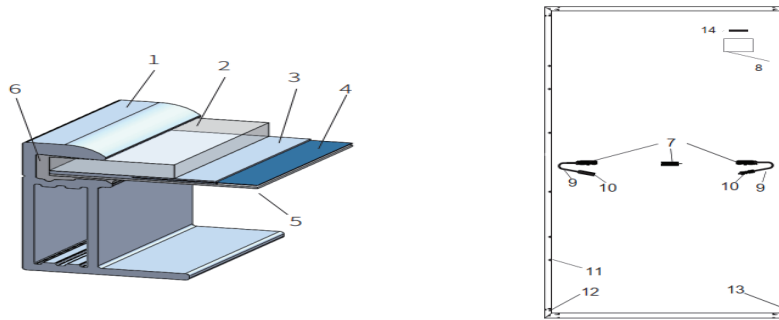





1. Aluminum alloy frame	2. PV Glass	3. EVA	4. Solar Cell
5. Backplate	6. Silicone	7. Junction Box	8. Nameplate
9. Cable Wires	10. Connector	11. Mounting holes	12. Grounding hole
13. Leakage hole	14. Bar Code		

(The rest of the version a corresponding solar panel specifications shall prevail)

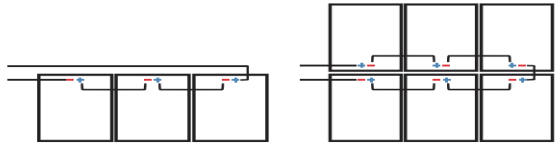
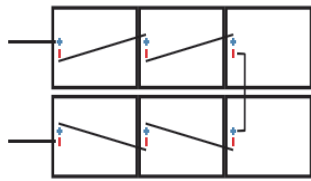

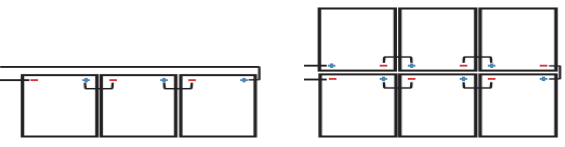
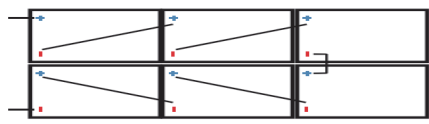
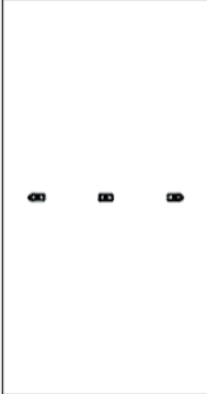
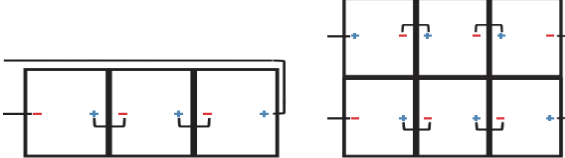
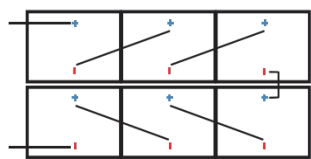
### 3.2. Junction box style and wiring method

Junction box location	Recommended connection & wiring method for series connection	
	Vertical installation: the standard line length can be (Note: can increase the extension line)	
	Horizontal installation: standard line length can be (Note: can increase the extension line)	
	Vertical installation: the standard line length can be (Note: can increase the extension line)	
	Horizontal installation: standard line length can be (Note: can increase the extension line)	
Junction box location	Recommended connection & wiring method for series connection	
	Vertical installation: the standard line length can be (Note: can increase the extension line)	
	Horizontal installation: standard line length can be (Note: can increase the extension line)	

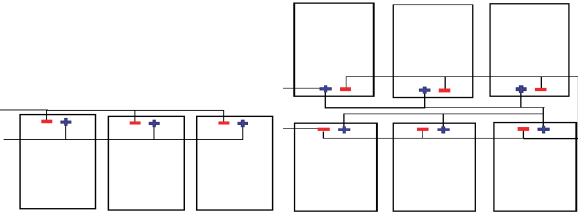
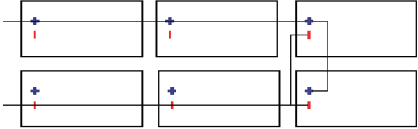
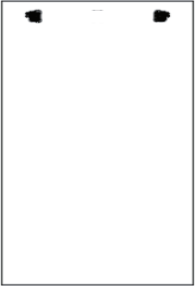
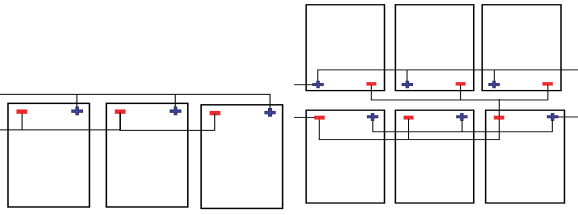
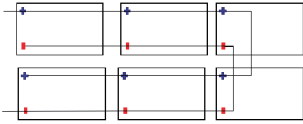
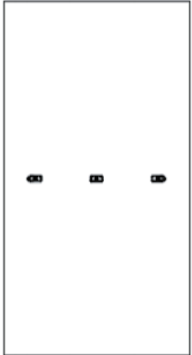
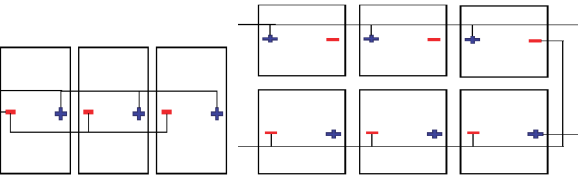
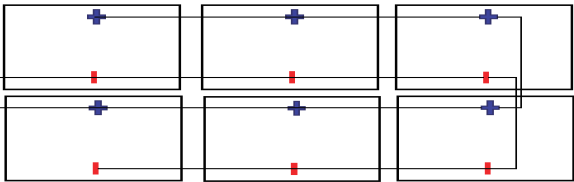
Junction box location	Recommended connection & wiring method for parallel connection	
	Vertical installation: the standard line length can be (Note: can increase the extension line)	
	Horizontal installation: standard line length can be (Note: can increase the extension line)	
	Vertical installation: the standard line length can be (Note: can increase the extension line)	
	Horizontal installation: standard line length can be (Note: can increase the extension line)	
Junction box location	Recommended connection & wiring method for parallel connection	
	Vertical installation: the standard line length can be (Note: can increase the extension line)	
	Horizontal installation: standard line length can be (Note: can increase the extension line)	
Attention & Notes	This table is for reference only, the actual wiring depends on the situation, try to reduce the length of the line, avoid cross-wiring.	

### 3.3. General Safety



When the modules are installed on the roof, the overall fire rating of the final structure needs to be considered. Also, the overall maintenance afterwards needs to be considered. For your safety, do not work on the roof without safety precautions including, but not limited to, fall protection, ladders or stairs and personal protective equipment. For your safety, do not install or handle components in hazardous environments, including but not limited to strong winds or gusts, wet or sandy roofs.

### 3.4. Electrical safety



Photovoltaic products generate direct current under light conditions, so take appropriate protective measures (insulated gloves, insulated shoes, etc.) to avoid direct contact between personnel and 30 V or higher DC voltages. 30 V or higher DC voltages are potentially fatal.

Components can also generate voltage when no load or external circuit is connected. Use insulated tools and wear rubber gloves when handling the modules in the sun.

Photovoltaic modules do not have switches. The module can only be made to stop working by moving the PV module away from the light or by covering it with cloth, cardboard or a completely opaque material.

To avoid arcing and electric shock hazards, do not disconnect electrical connections with a load. Incorrect connections can also cause arcing and electric shock. Connectors must be kept dry and clean to ensure they are in good working condition. Do not insert other metal objects into the connectors or make electrical connections in any other way.

Snow and water or other reflections from the surrounding environment can increase the intensity of the irradiation received by the module and can cause an increase in output current. The output voltage of the module will also increase appropriately at low temperatures.

If the module glass or other encapsulation material is damaged, wear personal protective equipment and separate the module from the circuit.

Touching wet components is strictly forbidden unless wearing shock protection equipment that meets the requirements; when cleaning components, you must follow the requirements of this manual for cleaning components.

The connector must not come into contact with the following chemicals: gasoline, white flower oil, live oil, mold temperature oil, motor oil (e.g. KV46), grease (e.g. Molykote EM-50L, etc.), lubricating oil, rust prevention oil, stamping oil, grease, diesel oil, cooking oil, acetone, alcohol, windex, ortho bone water, tenax, mold release agents (e.g. Pelicoat S-6, etc.), sticky board adhesive and potting Sealant (such as KE200, CX-200, chemlok, etc.), TBP (plasticizer), cleaning agent, etc.

### 3.5. Operation Safety



- To ensure the safety of the components during transportation and storage, unpack the components upon arrival at the installation site.
- Protect the packaging from damage or dropping.
- It is forbidden under any circumstances to lift the entire module by grasping the junction box or wires.
- Do not stand or walk on the module.
- Do not apply excessive loads on the module or twist the module in order to avoid glass breakage.
- Do not drill holes in the module bezel, as this will result in a reduction in the bezel's resistance to load and lead to corrosion of the bezel, thereby voiding the warranty;
- Do not scratch the anodic oxide layer on the surface of the aluminum bezel, except when grounding connections are made. Scratching may lead to frame corrosion, affecting the frame's load resistance and long-term reliability.
- Self-repair of components is strictly prohibited



### 3.6. Fire Protection and Safety



Please refer to local laws and regulations before installing the components and comply with them regarding building fire resistance requirements. Ensure adequate ventilation between the backsheet and the installation surface during installation. The structure of the roof and the way it is installed can affect the fire safety performance of the building. If not properly installed, a fire may result. To ensure the fire rating on the roof, the minimum distance between the module frame and the roof surface is 10 cm. When mounting the module on the roof of a vehicle, if brackets are used, the module must be mounted on the brackets and must not be tightly bonded to the roof itself. Use proper module accessories such as fuses, circuit breakers, and ground connectors as required by local codes. Do not use the module if there are exposed combustible gases in the vicinity.

## 4. Renogy solar panels installation method

### 4.1. Installation location and environment

The components are not suitable for space environment.

Do not use mirrors or magnifying glasses to artificially focus sunlight on the modules.

Do not install the module in a location where there is a risk of water flooding.

It is recommended that the modules be installed in an ambient operating temperature of  $-40^{\circ}\text{C}$  to  $40^{\circ}\text{C}$ , which is the average monthly maximum and minimum temperature at the installation site. The maximum ambient operating temperature of the module is  $-40^{\circ}\text{C}$  to  $85^{\circ}\text{C}$ .

Ensure that the module is not subjected to wind or snow pressure exceeding the maximum allowable load after installation.

The module needs to be installed in a location where there is no shade all year round. Make sure that there are no obstacles that may block the light at the module installation site.

If the modules are installed in a location where there is frequent lightning activity, the modules must be protected from lightning strikes.

Do not install and use modules near flames or combustible materials.

Modules must not be installed or used in environments subject to excessive hail, snow, sand, soot, air pollution, soot, etc.

Components are strictly forbidden to be installed on the installation surface that is susceptible to aging and corrosion by the environment. For example: wood, PVC plastic, etc.

### 4.2. Selection of inclination angle

Module inclination: The angle between the surface of the module and the horizontal plane. When the module is facing the sunlight, the module will get the maximum power output.

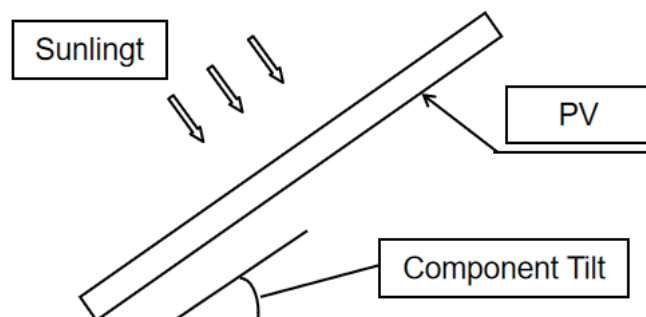

For installation in the Northern Hemisphere, modules should preferably face south, and for installation in the Southern Hemisphere, modules should preferably face north.

For detailed installation angles, please follow the standard module installation guidelines or the recommendations given by experienced PV module installers.

It is recommended that the mounting angle of the modules be not less than 10 degrees (RV depending on the actual situation), so that the surface dust of the modules can be easily carried away by rainwater when it rains, thus reducing the number of module cleaning; at the same time, it is conducive to the flow of water on the surface of the modules, avoiding a large amount of water from accumulating on the glass for a long period of time and leaving marks on the glass, which in turn affects the appearance and performance of the modules.

Serially connected/parallel connected modules should be installed in the same orientation and angle. If the orientation or angle is different, it may cause different amount of solar radiation received by each module, which may lead to output power loss. To achieve maximum annual

power production, the optimal orientation and tilt of the PV modules in the area where they are installed should be selected to ensure that sunlight can still reach the modules even on the shortest sunny day of the year.

If connected to a stand-alone PV system, the angle of installation of the modules should be based on the season and light conditions to obtain maximum power output. Generally speaking, if the output of the modules can be met even on the lowest light intensity of the year, then the output of the modules at the chosen angle will meet the year-round demand.



## 5. Renogy solar panels installation - Mechanical installation

### 5.1. General Requirements

- PV panels can be installed vertically or horizontally, and please keep the drain holes on the frame unblocked.
- Please keep the backboard of the PV panels untouched with any other structures especially when there are external pressure on them.
- Please leave at least 10mm gap between PV panels in case of any potential damage caused by thermal expansion and contraction.
- Please assure the installation site, such as the roof of the house or RV, is properly sealed and appropriate for installation in case of unexpected problems and permeating.
- Please leave a 10cm clearance between the frame of PV panels and the roof or the wall to secure the ventilation and dissipation of moisture when the PV panels are installed on the mounting brackets parallel to the wall or the roof.
- Please ensure the PV panel(s) is mounted firmly on the roof of the house or RV.

### 5.2. Mechanical mounting of single-sided & double-sided components



Renogy currently offers components that can be installed mainly by the bolt-on or bracket mounting methods. Installation of components must be done in accordance with the examples and recommendations below.

Contact Renogy prior to using alternative mounting methods since it may void the warranty.

#### 5.2.1. Bolt mounting method

Renogy components are equipped with corresponding mounting holes, the number & corresponding size are detailed in the corresponding component layout; currently, the only mounting method provided by our company is bolt mounting. The corresponding bolt type/size diagram and the matching module version are as follows.

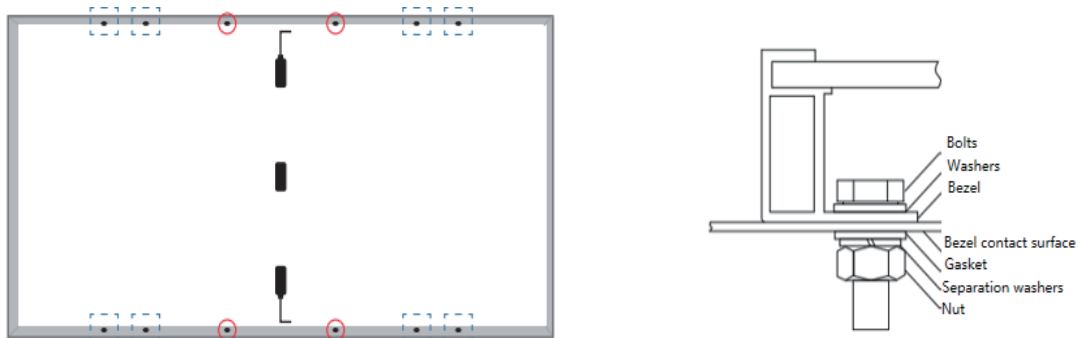

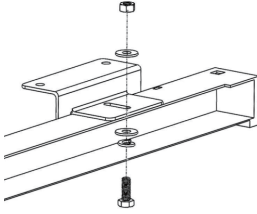

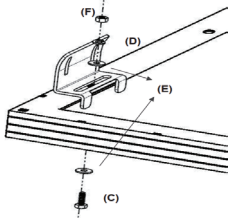

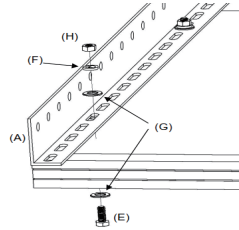
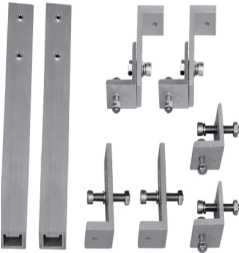
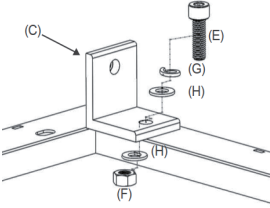

Figure 2 Schematic diagram of single-sided component mounting holes  
(The remaining component mounting holes are shown in the corresponding component layout)

SKU	Number per set	Bolt size	Pictures	Installation schematic	Applicable component models
MTS-ZB	4	M6			RSP100D-BK RNG-100D-SS RNG-30D-SS RNG-50D-SS RNG-175D(Two sets are recommended) RSP-200D(Two sets are recommended)
MTS-ACB	4 (Each set has 2 parts)	M6			RSP100D-BK RNG-100D-SS RNG-30D-SS RNG-50D-SS RNG-175D(Two sets are recommended) RSP-200D(Two sets are recommended)
Remarks	Please choose the number of bolts and installation method according to the installation environment, conditions and actual situation.				

### 5.2.2. Bolt mounting method with brackets

Renogy also offers its customers an angled mounting bracket that allows the customer to freely adjust the angle of the module to the light during installation. The corresponding mounting method is also bolt-on. The module is fixed to the bracket by means of bolts.

SKU	Number of matching solar panels	Bolt size	Pictures	Installation schematic	Applicable component models
MTS-TMB	1 Set for 1 panel	M6			RSP100D-BK RNG-100D-SS RSP80D-SS RNG-30D-SS RNG-50D-SS
MTS-TM100	1 Set for 1 panel	M8			RSP100D-BK RNG-100D-SS RNG-50D-SS RNG-175D RSP-200D RSP450D-120X2 RSP550D-144X2 RNG-320D
Remarks	Please choose the number of bolts and installation method according to the installation environment, conditions and actual situation.				

### 5.2.3. Mounting method of brackets

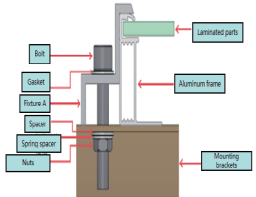
SKU	Number of matching solar panels	Bolt size	Pictures	Installation schematic	Applicable component models
MTS-SP100	1 Set for 1 panel	M8			RSP100D-BK RNG-100D-SS
Remarks	Please choose the number of bolts and installation method according to the installation environment, conditions and actual situation.				

### 5.2.4. Other installation methods

SKU	Number of matching solar panels	Bolt size	Pictures	Installation schematic	Applicable component models
MTS-CB	1 Set for 1 panel	/		/	All solar panels
Remarks	This mounting method requires no additional drilling and is suitable for all Renogy solar panels. The module needs to be pre-fixed with silicone for installation.				

## 5.3. Introduction of flexible module installation method

For flexible modules, Renogy recommends the use of silicone mounting on the roof. The roof should be cleaned before installation to ensure that the surface is free of dirt and foreign matter, and the back of the module should be cleaned to ensure that the back of the module is free of dirt and foreign matter. This will ensure a strong adhesion between the backsheet and the roof. The silicone mounting method is widely used for flexible modules, which fully combines the mechanical properties of flexible modules and to a certain extent avoids mechanical damage during subsequent use.

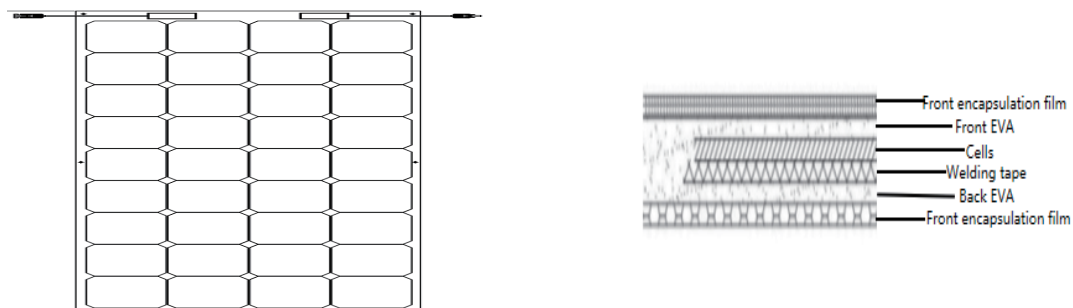
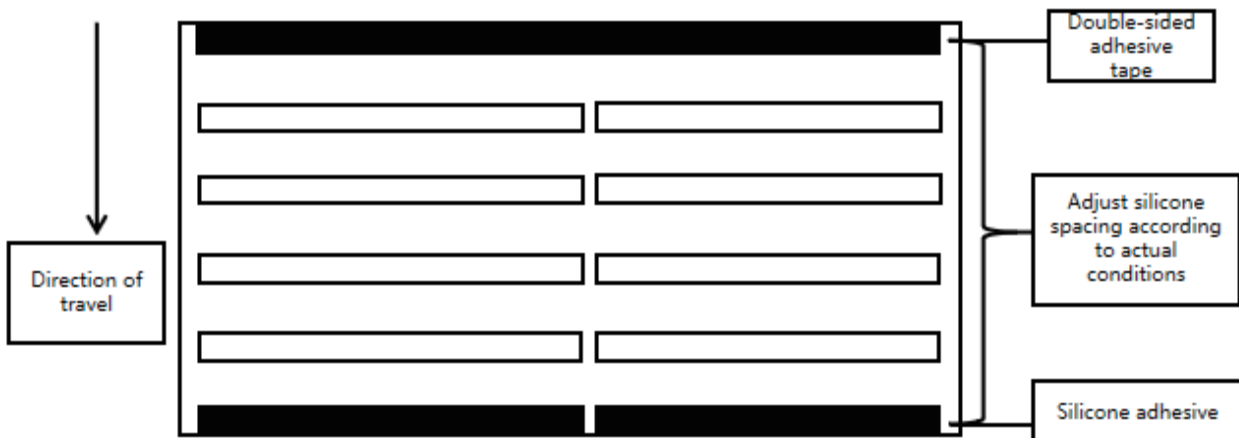

Figure 3 Schematic diagram of the structure of flexible components  
(The rest of the component structure diagrams are based on the corresponding)

### 5.3.1. Introduction to flat roof mounting methods

After cleaning the surfaces of the modules, stick double-sided tape on each short edge of the component for fixing. Apply silicone along the component horizontally with a width of 6~10mm and a thickness of 3~5mm. Silicone length application is to be adjusted according to the length of the component, with a recommended spacing of 10mm between lines. The spacing allows for heat dissipation and lets water run down. The component needs to be mounted within 5 minutes to prevent the silicone from curing and affecting the bonding performance. After mounting, the component needs to be lightly pressed along the bonding surface in the same direction the silicone was applied using a professional pressing tool. The distance between the two components being 5~10mm.



**Long side facing the direction of travel**

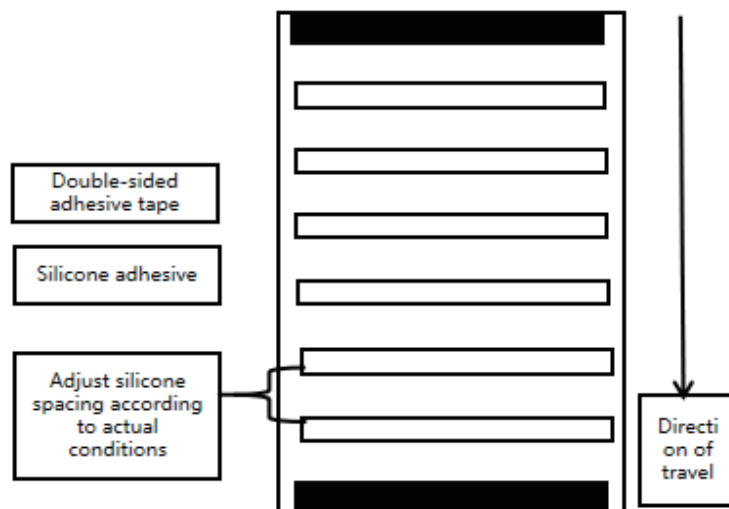

**Short side facing the direction of travel**

#### Operating notes.

- When applying silicone, it is important to not completely seal all four sides of the flexible component, as this can affect heat dissipation and drainage. Renogy recommends ensuring that at least the short edges are not sealed to ensure proper heat dissipation and drainage and to avoid the risk of fire.
- The number of horizontal silicone glue applications can be adjusted according to personal preference. Renogy recommends applying glue to the edge of the double-sided tape with a width of 6-10mm and a thickness of 3-5mm.
- Double-sided adhesive tape should be flush with the edge as much as possible.

- After the installation is completed, it should be left for 72H to ensure that the silicone is fully cured, avoiding direct sunlight, rain and other harsh weather during the curing period.
- The maximum bend of the flexible module can reach 240°, but this bend is for the convenience of storage, the actual installation is recommended to install the flexible module horizontally, or the installation bend is less than 30° to ensure power generation efficiency.
- When a short edge is used as the bending edge, the bending angle must not exceed 30°.

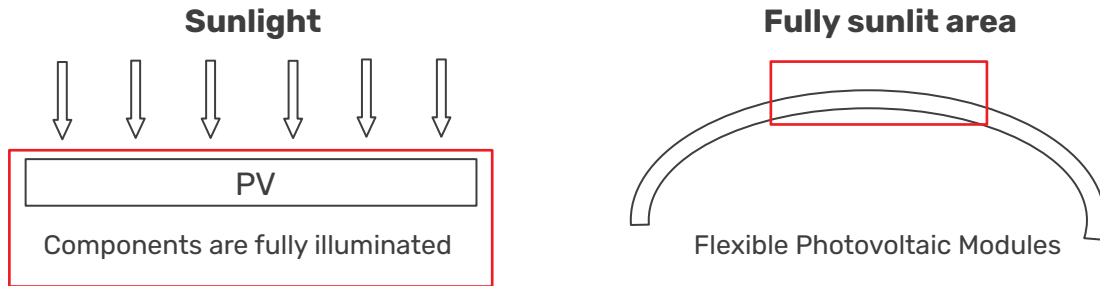

Note: As the installation angle becomes more curved, the non-illuminated area of the module will increase. When the bending radius exceeds 30 degrees, the non-illuminated area of the module will exceed 30%, which will affect the output of the module.

### 5.3.2. Introduction to non-flat roof mounting methods

After cleaning the flexible modules, stick double-sided tape on each long edge of the component for fixing. Apply the silicone according to the width of the corrugated roof protrusion; install the component within 5 minutes after finishing the silicone application to prevent the silicone from curing and affecting the bonding performance. Use a professional pressing tool and lightly press the surface of the component along the direction of gluing. The distance between the two components is 5~10mm.

After the installation of the silicone part is completed, the flexible component can be further fixed by applying bolts according to the mounting holes that come with the flexible component itself.

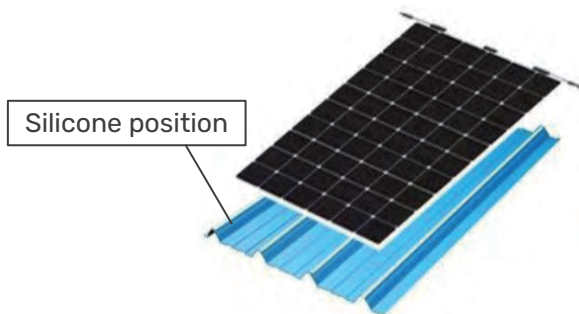

Figure 3: Non-flat gluing diagram

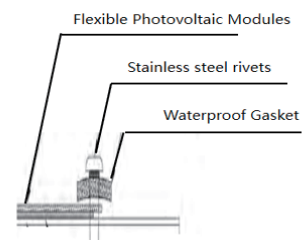

Figure 4: Schematic diagram of flexible component mounting holes

Note: Renogy recommends that non-flat roof need to meet a minimum of 6 silicone lines on the back side, if this condition is not met, the flexible module is not suitable for this roof.



## 6. Renogy solar panels installation - Electrical installation

### 6.1. Electrical parameters

The nominal values of electrical performance parameters for components, such as  $I_{sc}$ ,  $V_{oc}$ , and  $P_{max}$ , are obtained under standard test conditions. The standard test conditions for components include an irradiance of  $1000W/m^2$ , cell temperature of  $25^{\circ}C$ , and air mass AM1.5.

When components are connected in series, the  $V_{oc}$  of the combination is the sum of the  $V_{oc}$  values of individual components, and the  $I_{sc}$  remains the same as that of a single component. When components are connected in parallel, the  $V_{oc}$  is the same as that of a single component, and the  $I_{sc}$  is the sum of the  $I_{sc}$  values of multiple components. Refer to the figure below. It is not recommended to connect components with different parameters, models, or brands in series or in parallel.

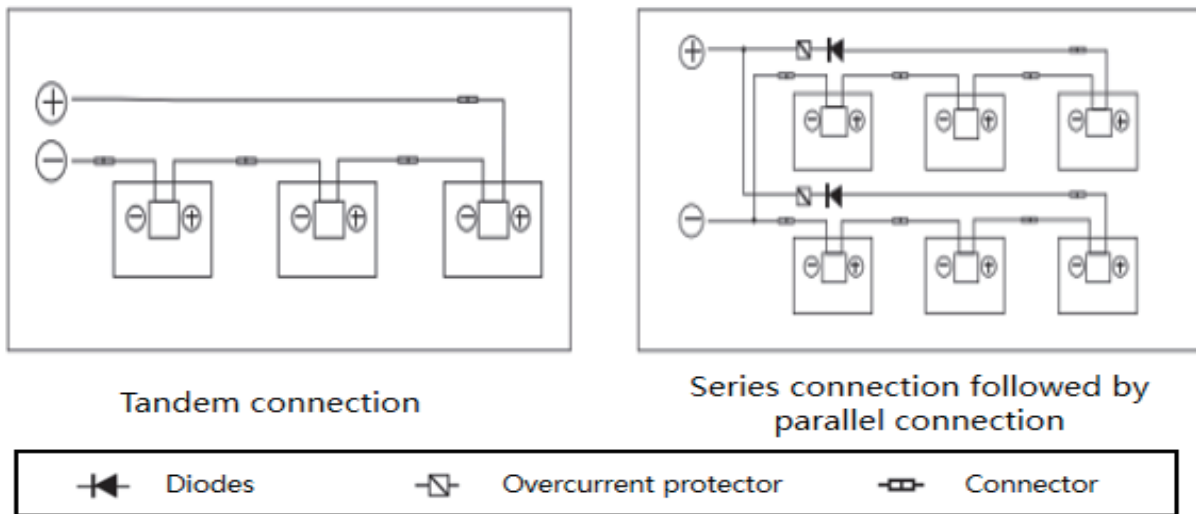

The maximum number of components that can be connected in series depends on the maximum system voltage supported by the component. After being connected in series under the lowest local temperature conditions, the open circuit voltage cannot exceed the maximum system voltage value specified by the component, such as DC600V/DC1000V/DC1500V. In practical applications, the number of components connected in series and parallel needs to be designed according to the parameters and models of the components and controllers.

The open circuit voltage correction factor can be calculated using the following formula:  $C_{Voc} = 1 - \beta V_{oc} \times (25 - T)$ .  $T$  is the expected minimum ambient temperature at the system installation location, and  $\beta$  ( $\%/^{\circ}C$ ) is the temperature coefficient of the selected component  $V_{oc}$  (refer to the corresponding component parameter table).

If there may be reverse current passing through the component that exceeds the maximum fuse current of the component, the same specification overcurrent protection device must be used to protect the component. If the number of components connected in parallel is greater than or equal to 2 in a series, there must be an overcurrent protection device on each series component, as shown in the figure above.

### 6.2. Cable and Wiring

#### 6.2.1 Introduction of cables and connections

Renogy modules use a junction box with a protection rating for connections (see module specification for details) to provide safe protection for the wiring and its corresponding connections and accessible protection for non-insulated live parts. The junction box consists of connected cables and connectors with corresponding protection ratings, which facilitate the series/parallel connection of modules. Each individual module has two wires connected to the junction box, one positive and one negative. The connection of the positive and negative poles of the modules can be achieved through the MC4 connectors.

Special solar cables and appropriate connectors should be used in accordance with local fire, building, and electrical regulations (the wires should be covered by aging-resistant conduits, and if exposed to air, should have aging-resistant properties), and the electrical and mechanical properties of the cables should be ensured.

After the cable is installed and connected, it should be protected from mechanical damage. Do not press the cable too hard. Although the cable is resistant to aging and waterproof, it should also be protected from direct sunlight and rain. The minimum bending radius of the cable should be 43mm.

### **6.2.2 Extension cable selection for component-to-component connection**

Renogy currently provides customers with inter-module connection cables mainly in the form of SKU: RNG-EXTCB, with a wire diameter specification of 10/12AWG, and a maximum length of 40FT for extension cables.

### **6.2.3 Extension cable for connecting the component to the controller**

Renogy currently provides customers with connection cables between modules and controllers mainly in the form of SKU: RNG-AK, with a wire diameter specification of 10/12AWG, and a maximum length of 40FT for extension cables.



## **6.3. Connector**

Please keep the connectors dry and clean, and ensure that the nut of the connector is in a tightened state before connecting. Do not connect the connectors if they are wet, dirty, or in any other unfavorable condition. If the connectors are not connected positively and negatively, they do not have waterproof function. After installing the modules, they need to be connected as soon as possible or appropriate measures need to be taken to avoid the infiltration of water vapor and dust. Avoid direct sunlight and immersion in water for the connectors. Avoid the connectors falling on the ground or on the roof, causing particles or dust to enter the connectors and affecting subsequent use. Incorrect connections may produce arcs and electric shocks. Please ensure that all electrical connections are secure. Make sure all locked connectors are fully connected. It is not recommended to use different types of connectors together.

## **6.4. Bypass Diode**

The solar cells in the solar module are connected in series with a bypass diode parallel protection, which is encapsulated in the junction box. When a hot spot phenomenon occurs in a module, the diode will start working to prevent the main current from flowing through the hot spot cell, thereby limiting the heating and performance loss of the module. Note that the bypass diode is not an overcurrent protection device. If the diode is suspected or confirmed to be faulty, please contact Renogy. It is strictly prohibited to attempt to open the junction box of the module on your own.

## 7. Renogy solar panels installation - Grounding

The design of the module uses anodized, corrosion-resistant aluminum alloy frames as rigid support. In order to ensure safe use and prevent damage from lightning and static electricity, the module frame must be grounded. When grounding, the grounding device must be in full contact with the aluminum alloy interior, penetrating the oxide film on the surface of the frame. It is strictly forbidden to add any additional grounding holes on the module frame. The grounding conductor or grounding wire can be made of copper, copper alloy, or any other material that meets the requirements of the corresponding national electrical specifications as a conductor. The grounding conductor must be connected to the earth through an appropriate grounding electrode. The holes marked with the grounding symbol on the frame can only be used for grounding and not for module installation. For modules without grounding holes, they can be grounded by connecting them to a grounded electrical device.

## 8. Renogy solar panels installation - Operation and maintenance

It is required to perform regular inspection and maintenance of the modules, especially during the warranty period. Please contact Renogy in 2 weeks if any abnormality or damage is found.



### 8.1. Solar panel cleaning

The accumulation of foreign substances (such as dust and bird droppings) on the glass surface of solar panels can affect their power output and even cause hotspots in the area. The extent of the impact depends on the transparency of the foreign material. For example, a small amount of dust on the glass surface can affect the intensity and uniformity of absorbed sunlight, this usually does not cause damage to the solar panel, and the power output usually does not decrease significantly. However, a large amount of dust accumulation, bird droppings, and shading by plants can form obstructions, which can significantly reduce power output and even form hotspots. It is recommended that the surface of the panels should not be obstructed by anything when there is sunlight.

The cleaning frequency depends on the how much foreign matter and debris accumulates. In many instances the front substrate gets cleaned with the rain, and you can decrease the cleaning frequency. It is recommended to wipe the glass surface with wet sponge or soft cloth. Please do not clean the glass with cleaning agent which contains acid or alkali.

To avoid potential electrical shock or burn, please clean the PV panels in the early morning or at dusk. Do not clean the PV panels with damage to the glass surface, backboard or wires.

### 8.2. Visual Inspection of PV Panels

Inspect the PV panels visually to find if there are appearance defect, especially:

- If the glass is broken;
- Corrosion along the cells' busbar. The corrosion is caused by moisture that has infiltrated into the modules when the surface encapsulation material damaged during the installation or transportation.
- If there is evidence of burning on the panel.
- Check the encapsulation of the connector with the cable.
- Ensure the PV panels are untouched with sharp objects.
- Ensure the PV panels are not shaded.
- Check the connection between the PV panels and the mounts and brackets.

### 8.3. Inspection of the Connector and the Cable



It's recommended to implement the following preventive maintenance every 6 months:

- Check the connections between the PV panels and other off-grid components.
- Check the sealing gel of the junction box to ensure if it is crack or crevice.

## 9. Schedule - Renogy solar panel iteration/mix recommendation

SKU	Versions	Size/mm	Mounting hole number & size	Recommended number of mounting holes	Mixable versions
RNG-10D-SS	G1	341 x 266	4-10*7	4	/
RNG-30D-SS	G1	570 x 341	4-10*7	4	/
RNG-50D-SS	G1	601 x 498	4-10*7	4	G1 / G2 / G3
RNG-50D-SS	G2	581 x 509	4-10*7	4	G1 / G2 / G3
RNG-50D-SS	G3	578 x 503	4-7*11	4	G1 / G2 / G3
RNG-80D-SS	G1	920 x 498	20-14*9	4	G1 / G2
RNG-80D-SS	G2	938 x 509	20-14*9	4	G1 / G2
RNG-100D-SS	G1	1074 x 798	20-14*9	4	G1 / G2 / G3
RNG-100D-SS	G2	1076 x 509	20-14*9	4	G1 / G2 / G3
RNG-100D-SS	G3	1062 x 530	20-14*9	4	G1 / G2 / G3
RNG-100MB	G1	1038 x 533	20-14*9	4	/
RSP100D-BK	G1	1100 x 509	20-14*9	4	G1 / G2
RSP100D-BK	G2	1062 x 530	20-14*9	4	G1 / G2
RNG-175D	G2	1262 x 699	20-14*9	4	G1 / G2
RNG-175D	G1	1328 x 670	20-14*9	4	G1 / G2
RSP200D	G3	1491 x 699	20-14*9	4	G1 / G2 / G3
RSP200D	G2	1650 x 670	20-14*9	4	G1 / G2 / G3
RSP200D	G1	1620 x 657	20-14*9	4	G1 / G2 / G3
RNG-320D	G1	1665 x 1002	4-14.5*6.5	4	G1 / G2
RNG-320D	G2	1665 x 1002	4-14.5*6.5	4	G1 / G2
RSP450D-120	G1	1909 x 1134	8-14*9	4	/
RSP550D-144	G1	2279 x 1134	8-14*9; 4-11*7	4	/
RNG-10DB-H	G1	481 x 301	6-Inner φ8;Outer φ14	6	G1 / G2
RNG-10DB-H	G2	481 x 301	6-Inner φ8;Outer φ14	6	G1 / G2
RNG-50DB-H	G1	673 x 508	6-Inner φ6;Outer φ11	4	G1 / G2 / G3
RNG-50DB-H	G2	683 x 508	6-Inner φ6;Outer φ11	4	G1 / G2 / G3

SKU	Versions	Size/mm	Mounting hole number & size	Recommended number of mounting holes	Mixable versions
RNG-50DB-H	G3	712 x 460	6-Inner φ6;Outer φ11	4	G1 / G2 / G3
RNG-100DB-H	G1	1219 x 546	6-Inner φ6;Outer φ12	6	G1 / G2 / G3
RNG-100DB-H	G2	1219 x 546	6-Inner φ6;Outer φ12	6	G1 / G2 / G3
RNG-100DB-H	G3	1093 x 582	6-Inner φ6;Outer φ11	6	G1 / G2 / G3
RSP100DL-36	G1	1093 x 582	6-Inner φ6;Outer φ11	6	/
RNG-175DB-H	G1	1504 x 673	6-Inner φ6;Outer φ12	6	G1 / G2
RNG-175DB-H	G2	1504 x 673	6-Inner φ6;Outer φ12	6	G1 / G2
RSP200DB-72	G1	1605 x 748	6-Inner φ6;Outer φ11	6	/



## Renogy Empowered

Renogy aims to empower people around the world through education and distribution of DIY-friendly renewable energy solutions.

We intend to be a driving force for sustainable living and energy independence.

In support of this effort, our range of solar products makes it possible for you to minimize your carbon footprint by reducing the need for grid power.



## Live Sustainably with Renogy

Did you know? In a given month, a 1kW solar energy system will...



Save 170 pounds of coal from being burned



Save 300 pounds of CO<sub>2</sub> from being released into the atmosphere



Save 105 gallons of water from being consumed



## Renogy Power **PLUS**

Renogy Power Plus allows you to stay in the loop with upcoming solar energy innovations, share your experiences with your solar energy journey, and connect with like-minded people who are changing the world in the Renogy Power Plus community.



@Renogy Solar



@renogyofficial



@Renogy

Renogy reserves the right to change the contents of this manual without notice.