



Anti-Theft System Operation & Installation Guide



Australia's Most Advanced Anti-Theft System for Caravans and Trailers

Contents

- Warnings & Safety Instructions
- Specifications
- Operating your WiTi Anti-Theft System
- Installing your WiTi Anti-Theft System
- Disclaimers & Warranty



Comes with:

- WiTi Anti-Theft System
- Door Switch
- PIR Motion Sensor
- 2 x Remote controls for arming and disarming
- 105db horn
- Wiring looms

Warnings & Safety Instructions



Do not operate WiTi unless you have read and understood this manual. Ensure WiTi is installed as per the instructions, failure to do so will void warranty.

Ensure the cable used to install WiTi Anti-Theft is of adequate thickness to provide the necessary current for the circuit.

WiTi Anti-Theft must be installed away from environmental conditions that may cause damage to the units circuitry including water, salt spray and humidity.

WiTi Anti-Theft is connected to the internal house battery of the caravan or trailer, insufficient charge of the house battery will affect the performance of the Anti-Theft functions. The condition of the battery in the caravan or trailer must be maintained and checked. Voltage of the house battery is displayed on the WiTi Wireless Brake Controller if installed.

NOTE : When servicing the electric brakes or magnets it is recommended WiTi is disconnected to prevent accidental short circuits.

Specifications

Nominal system voltage	12V
Operating voltage	12V-14.5V DC
Standby current	0.07A
Operating temperature	-20C – 70C
Max. trailer axles	3 Axles
Braking circuit max draw	25A
Maximum rated current	30A
Weight	300g

Operating your WiTi Anti-Theft System

WiTi Anti-Theft is Australia's leading Anti-Theft and Intrusion Detection System designed for caravans and trailers.

In the event an attempt is made to tow the caravan or trailer the Anti-Theft system will be activated. All the lights flash, the alarm sounds and the brakes are applied making it impossible to tow the caravan or trailer. This continues as long as movement is detected. Once movement ceases WiTi Anti-Theft will reset after 30 seconds. WiTi Anti-Theft is sensitive to acceleration and high frequency impacts (metal on metal). A sideways / rocking motion has been programmed out to prevent activation in windy conditions.

WiTi Anti-Theft includes a Passive Infra Red Motion Sensor and a Magnetic Door Switch. If the door is opened or movement is detected within the caravan or trailer then the system will be activated. The Motion Sensor can be switched on/off via the switch on the side of the Motion Sensor Unit. By switching off the Motion Sensor the alarm can be activated while moving around inside the caravan.

To activate WiTi Anti-Theft, press button A on the remote control, the side and front markers and indicators will flash once followed by a 3 second safety pause and then a double flash to indicate the system is armed. The Alarm Status LED will illuminate. To deactivate, press button A again, the side and front markers and indicators will flash once and the Alarm Status LED will switch off.

Button B on the remote control activates an emergency Panic Alarm. To activate the Panic Alarm, press and hold Button B for 3 seconds. To deactivate press and release button B again.

WiTi incorporates an advanced safety system to ensure the system cannot be accidentally activated whilst the caravan or trailer is being towed. After activating the system, if movement is detected during the 3 second safety pause the system will not arm. The lights will not flash twice and the Alarm Status LED will not illuminate.



WiTi Anti-Theft front panel indicator lights

There are two LED's embedded in the WiTi logo. When the unit is receiving power the orange LED will illuminate. When the unit is paired and linked to a WiTi Wireless Brake Controller or WiTi Wireless Towing Interface then the red LED will illuminate.

The 7 coloured LED's correspond to the various outputs and are colour matched to the wires on the wiring loom. These will illuminate when the corresponding output is active. This will assist with fault finding and confirming that the outputs are functioning correctly.

LI - left indicator

RI - right indicator

BL - brake light

DL - driving lights and side markers

RL - reverse light

SB - service brakes

IG - vehicle ignition

The following LED's describe fault conditions:

SC - short circuit

RP - reverse polarity

OV - over voltage

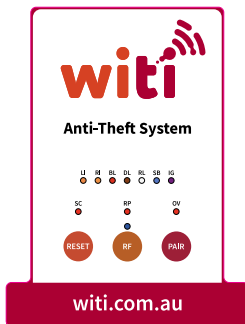

The RESET and PAIR buttons are used to pair WiTi Anti-Theft to a WiTi Wireless Brake Controller or WiTi Wireless Towing Interface. Please follow the instructions contained in those guides for the pairing process.

The RF button is used to programme remote controls and sensors to WiTi Anti-Theft.

Programming Remote Controls and Sensors

The WiTi Anti-Theft system is supplied with two remote controls, a Passive Infra-Red Motion Sensor and a Magnetic Switch Sensor. Additional PIR Motion Sensors and Magnetic Door Switches can be purchased from WiTi and added to your existing system by following the instructions below.

Programming remote controls

For each new remote control, press the RF Button on the front panel. The blue LED above the button will flash once to indicate it is in pairing mode. Now press Button A on the remote control and the LED will flash repeatedly for a few seconds. Repeat for Button B.

Programming the PIR Sensor

Turn the power off on the PIR by using the slide switch located on the left hand side of the unit. Press the RF button on the front panel and the LED will flash once to indicate it is in pairing mode. Now turn the power on on the PIR with the switch on the side of the PIR. The LED will flash repeatedly for a few seconds. The PIR is now programmed. Multiple PIR units can be programmed by repeating the above instructions.

Programming the Magnetic Door Switch

Ensure the door is closed. Press the RF button on the front panel and the LED will flash once to indicate it is in pairing mode. Open the door and the LED will flash repeatedly for a few seconds. The door magnet is now programmed. Multiple Magnetic Door Switches can be programmed by repeating the above instructions.

Clearing all programmed units

To clear all previously programmed units press and hold the RF Button on the front panel for 10 seconds. This will erase all previously programmed remote controls and sensors.

Replacing batteries in Remote Controls and Sensors

Remote Controls

Remove the three small screws on the back cover of the remote control and remove the cover. Replace the battery with type 27A 12V. Replace the cover and tighten the three small screws in place.

PIR Motion Sensor

Switch off the PIR with the slide switch on the side of the unit. Remove the screw at the base of the unit and gently pry off the cover. Replace the battery with a standard 9V Alkaline battery. Replace the cover and tighten the screw at the base of the unit.

Magnetic Door Switch

Pry the cover off the larger magnetic switch component, the one with the blue LED. Remove the old battery and replace it with type 23A 12V. Replace the cover.

* Please discard old batteries in a responsible manner.

Installation Instructions

WiTi Anti-Theft System

The unit must be installed vertically and facing either the front or rear of the caravan or trailer with the wiring harness protruding from the bottom of the unit. WiTi uses gravity to initialise the gyroscope and detects acceleration in the direction of travel. If not installed correctly functionality will be compromised. The unit must be installed inside the caravan or trailer and it is recommended the unit is installed towards the front of the caravan or trailer. This will make the unit more sensitive to attempts to hitch up or knocks onto the tow hitch. The unit can be screwed onto a panel through the mounting lugs using appropriate sized screws.

The horn is weather proof so it can be installed externally.

The Alarm Status LED outputs must be connected to the supplied 12V LED as per the wiring instructions. The LED will light when the alarm is armed and switch off when the alarm is disarmed. Install the LED in an area which is visible to the user.

The caravan or trailer battery must be connected to an acceptable charging circuit - either solar panels, anderson plug or DCDC charger.

The wiring loom is supplied with two inline fuses for the power circuit and service brake circuit. The power circuit must be protected by a 30A fuse and the service brake circuit by a 25A fuse. In the case of a single axle caravan or trailer this can be replaced by a 20A fuse.

PIR Motion Sensor

Install the PIR inside the caravan / trailer facing North/South so that it will detect movement along the length of the van. The PIR has a range of 11m and will cover the entire length of the caravan. Do not install it under or near an air conditioning unit, near a heat source (oven / extractor fan) or in an area which receives direct sun light. Install at a height of approximately 2m above the floor. Turn the sensor on with the switch on the side of the unit, the LED will flash briefly and the Sensor will run a self test for approximately 30 seconds, it will then enter normal operating mode. If movement is detected a signal will be sent to the WiTi Anti-Theft System causing it to activate the alarm. If the battery is low and needs replacing, the LED will flash rapidly.

Magnetic Door Switch

Install the door switch on either side of the door frame in a manner such that opening the door will cause the two components to move apart thus activating the sensor. Mount each side using the double sided tape included with the switch.

When the switch is activated a blue LED will light and a signal will be sent to the WiTi Anti-Theft System causing it to activate the alarm. If the battery is low and needs replacing, the LED will flash red.









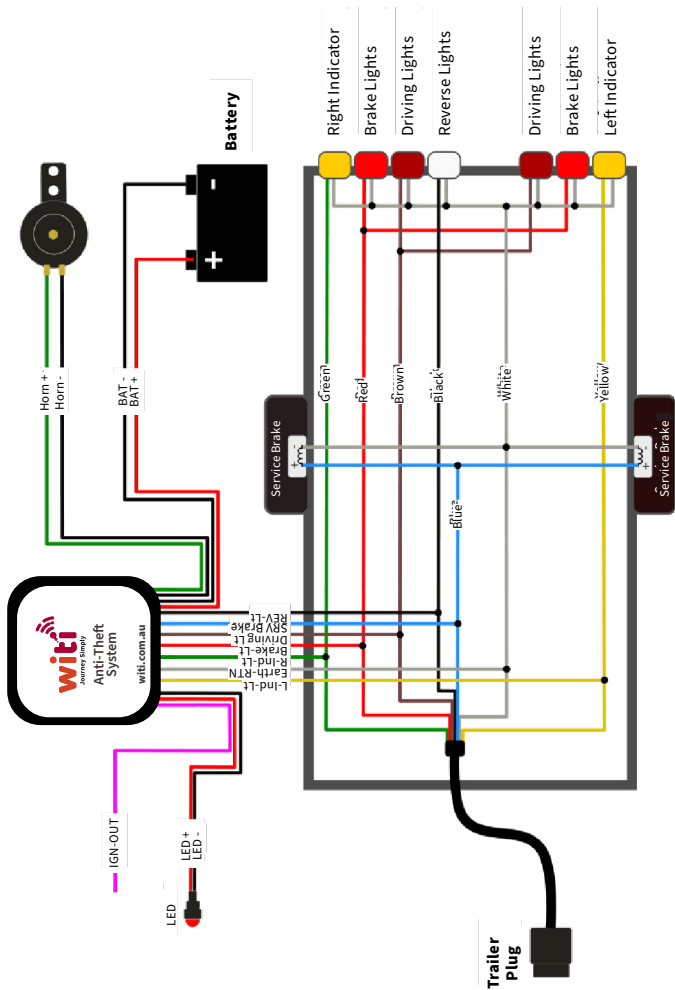

Circuit Protection and Fault Conditions

In the event a short circuit or an overload is detected, WiTi Anti-Theft will disable all functions and the corresponding LED will light on the front panel. All functions will cease until the error has been addressed and the appropriate circuits repaired.

In the event of a reverse polarity the corresponding LED will light and all power to the circuit board will be cut.

NOTE: When servicing the electric brakes or magnets it is recommended WiTi is disconnected to prevent accidental short circuits.



Colour		Label	Function
Yellow		L-Ind-Lt	Left Indicator
Green		R-Ind-Lt	Right Indicator
Red		Brake-Lt	Brake Light
Brown		Head-Lt	Park Lights and Markers
Black		Rev-Lt	Reverse Lights
Blue		SrBrake	Electric Brake Output
White		Earth RTN	Earth Return
Purple		IGN-Out	Ignition feed - Not used on WiTi Anti-Theft System
Green		Horn +	Alarm Horn Pos output. Connect to horn.
Black		Horn -	Alarm Horn Negative. Connect to horn.
Red		LED +	Alarm Status LED 3.3V+. Connect to positive LED.
Black		LED -	Alarm Status LED 3.3V-. Connect to negative LED.
Red		BAT +	12V+ connect to positive terminal on house battery and protect with a 30A fuse.
Black		BAT -	NEG connect to negative terminal on house battery.

Limited Warranty

If Leisure Technologies determines that you are covered by a warranty as set in the Australian consumer law the company shall at its expense: (a) repair the product or replace the product with a new unit (which may have used refurbished parts of similar quality); (b) ship the repaired or replaced unit back to you; (c) warrant the repaired or replaced product for a reasonable period; and/or (d) refund money paid for the product. The Company has the discretion as to which remedy applies.

Warranty period

The warranty period starts on the date of purchase and ends 24 months later. For the purpose of this limited warranty, the date of purchase is the date indicated on the original bill of sale or receipted invoice for the product from the vendor from which you acquired this product.

How to get warranty service

During the warranty period, if you wish to return a defective product you may contact us via www.witi.com.au. You may then return the defective product to the address given accompanied by an acceptable proof of purchase (a bill of sale or receipted invoice).

What is not covered

The limited warranty does not cover a product:
for which you are not the original purchaser;

- that is damaged by using it in a way that was unreasonable or unintended;
- that is returned after the applicable warranty period set out above has expired;
- that has been installed other than per the product installation guidelines;
- that has been maintained, altered or modified, opened or repaired, other than by the company or by a company authorised service centre; that has been physically damaged, other than by the company or a company authorised service centre.

To the extent permitted by law, Leisure Technologies, its directors, officers, employees, suppliers and agents, shall not be liable for injury to persons or property, or for any indirect, special, incidental or consequential, punitive or exemplary damages and liability and shall be limited to the amount you paid for the product.

Other important notices

To the extent permitted by law, this limited warranty constitutes the entire agreement on the subject matter and supersedes any prior agreement or understanding, written or oral. Where used herein, the company shall mean Leisure Technologies Pty Ltd and its subsidiaries and associates.

Our goods come with guarantees that cannot be excluded under the Australian consumer law. You are entitled to a replacement or refund for a major failure and for compensation for any other reasonably foreseeable loss or damage. You are also entitled to have the goods repaired or replaced if the goods fail to be of acceptable quality and the failure does not amount to a major failure. The benefits under your warranty are in addition to other rights and remedies under the law in relation to the product.

Disclaimer

WiTi products are designed for installation by reasonably competent consumers. Consumers are taken to have sufficient knowledge of the intended caravan or trailer unit and its appropriateness for the installation of any WiTi products.

Prior to the installation of any WiTi product consumers are taken to have comprehensively read and understood the appropriate WiTi operation and installation guide included with the product.

Installation of WiTi products may require consumers to have knowledge and experience using powered tools and electrical wiring. Consumers without such knowledge are to refrain from attempting any installation of WiTi products and to consult their nearest WiTi specialist or qualified Auto Electrician.

It is the consumer's sole responsibility to have WiTi products properly installed on their vehicle and/or trailer units along with any modifications necessary for the proper installation of WiTi products. Consumers are solely and completely responsible for evaluating their trailer units to ensure that the trailer units, and each part thereof, is appropriate, adapted, and applicable for installation and use of WiTi products.

Any and all WiTi unit damages caused by a consumer's failure to modify the caravan or trailer properly for installation and use of one or more WiTi products not covered by this disclaimer is the sole responsibility of the consumer.

Leisure Technologies Pty Ltd and their distributors and resellers also expressly disclaims all liability for direct, indirect, special, incidental, or consequential damages, including but not limited to, damage or loss of property or equipment, injury to person whether physical or not, loss of profits or revenue, cost of purchase or replacement of goods, or claims of customers of the purchaser that result from the incorrect installation of any WiTi Anti-Theft unit or subunit.

witi

Journey Simply



Scan to discover more

witi.com.au